

# RADIO & ELECTRONICS CONSTRUCTOR

**MARCH 1980**  
**Volume 33 No. 7**

Published Monthly

First published in 1947

*Incorporating The Radio Amateur*

*Editorial and Advertising Offices*  
57 MAIDA VALE LONDON W9 1SN

Telephone 01-286 6141      Telegrams Databux, London

© Data Publications Ltd., 1980. Contents may only be reproduced after obtaining prior permission from the Editor. Short abstracts or references are allowable provided acknowledgement of source is given.

**Annual Subscription:** £8.00, Eire and Overseas £9.00 (U.S.A. and Canada \$20.00) including postage. Remittances should be made payable to "Data Publications Ltd". Overseas readers, please pay by cheque or International Money Order.

**Technical Queries.** We regret that we are unable to answer queries other than those arising from articles appearing in this magazine nor can we advise on modifications to equipment described. We regret that queries cannot be answered over the telephone, they must be submitted in writing and accompanied by a stamped addressed envelope for reply.

**Correspondence** should be addressed to the Editor, Advertising Manager, Subscription Manager or the Publishers as appropriate.

**Opinions** expressed by contributors are not necessarily those of the Editor or proprietors.

**Production**— Web Offset.

ICM7555 — Suggested Circuit by G. A. French	398
NEWS AND COMMENT	400
STEREO MIXER UNIT by R. A. Penfold	402
RADIO-COUPLED MORSE OSCILLATOR by T. Bowen	407
SHORT WAVE NEWS — For DX Listeners by Frank A. Baldwin	408
BRITAIN'S FIRST AMATEUR SPACECRAFT TO BE LAUNCHED IN 1981	410
INTERRUPTS — Databus Series No. 8 by Ian Sinclair	411
WILDLIFE RADIO AID by P. Manners	414
IN NEXT MONTH'S ISSUE	415
INFRA-RED INTRUDER ALARM by M. V. Hastings	416
GOOD CONNECTIONS — by V. T. Powell	422
SIMPLE S.W. SUPERHET — Part 2 — Conclusion by R. A. Penfold	424
TRADE NOTE — Peak Programme Meters	426
VIDEO A.C. COUPLING by R. Webber	427
THE "WATERSPORT" MEDIUM-LONG WAVE PORTABLE — Part 2 — Conclusion by Sir Douglas Hall, Bt., K.C.M.G.	
BEGINNERS PLEASE! — In Your Workshop Questions on resistors and capacitors	435
RADIO TOPICS — by Recorder	440
NEW PRODUCTS	442
CONTACT BOUNCE — Electronics Data No. 55	iii

Published in Great Britain by the Proprietors and Publishers, Data Publications Ltd, 57 Maida Vale, London W9 1SN.

The *Radio & Electronics Constructor* is printed by Swale Press Ltd.

**THE APRIL ISSUE  
WILL BE PUBLISHED  
EARLY IN MARCH**

<p><b>MOTORS</b> 1.5-6VDC Model Motors 22p. Sub. Min. 'Big Inch' 115VAC 3 rpm Motors 32p. 12VDC 5 Pole Model Motors 37p. 8 track 12V Replacement Motors 55p. Cassette Motors 5-8VDC ex. equip. 70p. Geared Mains Motors (240V) 2.5 rpm 75p. 115VAC 4 rpm Geared Motors 95p.</p>	<p><b>JUMPER TEST LEAD SETS</b> 10 pairs of leads with various coloured croc clips each end (20 clips) 90p per set.</p>	<p><b>LOW COST PANEL METERS</b> Dimensions 52 x 52 x 33mm, 50 microamp £4.25 100 microamp £4.10 IMA £3.95, VU meter £4.65. 0-300VAC (60 x 47 x 33mm) £4.25. Ferranti 3.5" square 0-600VAC meter only £2.95.</p>	<p><b>AEROSOL SERVICE AIDS, SERVISOL</b> Switch Cleaner 226gm 60p. Freezer 226gm 70p. Silicone Grease 226gm 70p. Foam Cleanser 370gm 60p. Plastic Seal 145gm 60p. Excel Polish 240gm 47p. Aero Klene 170gm 55p. Aero Duster 200gm 70p.</p>	<p><b>TOOLS</b> SOLDER SUCKER, plunger type, high suction, teflon nozzle, £4.99 (spare nozzles 69p each). Good Quality snub nosed pliers, insulated handles, 5" £1.45. Antex Model C 15 watt soldering irons, 240VAC £3.95 Antex Model CX 17 watt soldering irons, 240VAC £3.95. Antex Model X25 25 watt soldering irons, 240VAC £3.95. Antex ST3 iron stands, suits all above models £1.65. Antex heat shunts 12p each. Servisol Solder Mop 50p each. Neon Tester Screwdrivers 8" long 59p each. Miyama IC test clips 16 pin £1.95.</p>
<p><b>SEMICONDUCTORS</b> LM340 80p. BY103 10p. 2N5062 100V 800mA SCR 18p. BX504 Opto Isolator 25p. CA3130 95p. TBA800 50p. 741 22p. 741S 35p. 723 35p. NE555 24p. 2N3773 £1.70. AD161/2 70p. ZN414 75p. BD238 28p. BD438 28p. IN4005 10 for 36p. TIL305 alpha numeric display £2.50. TIL209 Red Leds 8p each. 0.5" 7 segment Led display. Comm. Cathode, green, full spec. 85p each.</p>	<p><b>TRANSFORMERS</b> All 240VAC Primary (postage per transformer is shown after price). MINIATURE RANGE: 6-0-6V 100mA, 9-0-9V 75mA and 12-0-12V 50mA all 79p each (15p). 0-6V. 280mA £1.20 (20p). 6V 500mA £1.20 (15p). 12V 2 amp £2.75 (45p). 15-0-15V 3 amp Transformer at £2.85 (54p). 30-0-30V 1 amp £2.85 (54p). 20-0-20V 2 amp £3.85 (54p). 0-12-15-20-24-30V 2 amp £4.75 (54p). 20V 2.5 amp £2.45 (54p).</p>	<p><b>CAR STEREO SPEAKERS</b> Shelf mounting In black plastic pods with 5" 5 watt speaker available in 4 ohms only £3.95 per pair.</p>	<p><b>SURPLUS BOARDS</b> No. 1. this has at least 11 C106 (50V 2.5A) plastic SCR's, one relay a unijunction transistor and tantalum capacitors £1.95. No. 2 I.F. Boards, these are a complete I.F. board assembly made for car radios, 465kHz, full set of I.F.'s and oscillator coils, trimmers etc., 40p each.</p>	<p><b>SWITCHES</b> Sub. miniature toggles: SPST (8 x 5 x 7mm) 42p. DPDT (8 x 7 x 7mm) 55p. DPDT centre off 12 x 11 x 9mm 77p. PUSH-SWITCHES, 16 x 6mm, red top, push to make 14p each, push to break version (black top) 16p each. G.P.O. Telephone handsets £1.95p. Electrolytic Caps. can type, 2,200mfd and 2,200mfd 50VDC 35p each.</p>
<p><b>PROJECT BOXES</b> Sturdy ABS black plastic boxes with brass inserts and lid. 75 x 56 x 35mm 65p. 95 x 71 x 35mm 75p. 115 x 95 x 37mm 85p.</p>	<p><b>TRIAC/XENON PULSE TRANSFORMERS</b> 1:1 (gpo style) 30p. 1:1 plus 1 sub. min. pcb mounting type 60p each.</p>	<p><b>MURATA MA401</b> 40kHz Transducers. Rec./Sender £3.50 pair.</p>	<p><b>CRIMPING TOOL</b> Combination type for crimping red blue and yellow terminations also incorporates a wire stripper (6 gauges) and wire cutter, with insulated handles only £2.30.</p>	<p><b>MICRO SWITCHES</b> Standard button operated 28 x 25 x 8mm make or break, new 15p each. Roller operated version of the latter, New 19p each. Light action micro, 3 amp make or break 35 x 20 x 7mm, 12p each. Cherry plunger operated micro, 2 normally open, 2 normally closed, plunger 20mm long (40 x 30 x 18mm) 25p each.</p>
<p><b>AMP MULTIWAY IN-LINE PLUGS AND SOCKETS, 3 way 35p, 6 way 45p, 12 way 55p, per pair.</b></p>	<p><b>MICROPHONES</b> Min. tie pin. Omni, uses deaf aid battery (supplied), £4.95. ECM105 low cost condenser, Omni, 600 ohms, on/off switch, standard jack plug, £2.95. EM507 Condenser, uni, 600 ohms, 30-18kHz., highly polished metal body £7.96p. DYNAMIC stick microphone dual imp., 600 ohms or 20K, 70-17kHz., attractive black metal body £7.75p. EM506 dual impedance condenser microphone 600 ohms or 50K, heavy chromes copper body, £12.95. CASSETTE replacement microphone with 2.5/3.5 plugs £1.35. INSERT Crystal replacement 35X10mm 40p. GRUNDIG electric inserts with FET preamp, 3-6VDC operation £1.00.</p>	<p><b>ELECTRICAL ITEMS</b> 13 amp 3 pin plugs plastic 27p, rubber 62p, 13 amp rubber extension sockets 42p, 12 way flexible terminal blocks; 2 amp 20p, 5 amp 24p, 10 amp 33p, 15 amp 47p. Standard batten (BC lampholders 27p).</p>	<p><b>POWER SUPPLIES</b> SWITCHED TYPE, plugs into 13 amp socket, has 3-4.5-6-7.5 and 9 volt DC out at either 100 or 400mA, switchable £3.45. HC244R STABILISED SUPPLY, 3-6-7.5-9 volts DC out at 400mA max., with on/off switch, polarity reversing switch and voltage selector switch, fully regulated to supply exact voltage from no load to max. current £4.95.</p>	<p><b>PUSH BUTTON UNITS</b> 6 way, 3 DPDT, 3 4 pole c/o 55p. 8 way, 5 DPDT, 3 4 pole c/o 70p. RANK ARENA magnetic cartridge pre-amplifier modules, new with connection details £1.95p.</p>
<p><b>CHANGEOVER REED SWITCH 2 1/2" Long 35p. Glass Mercury Switch 1 1/2" x 3/8", long leads, 35p.</b></p>	<p><b>LIGHT DIMMER</b> 240VAC 800 watts max. wall mounting, has built in photo cell for automatic switch on when dark £4.50</p>	<p><b>VERNIER DIALS</b> 6:1 ratio, scaled 1-10, standard 6.3mm spindle, VD1 36mm diameter £1.95. VD2 50mm diameter £2.85. VD3 70mm diameter £3.75.</p>	<p><b>AMPHENOL CONNECTORS</b> (PL259) PLUGS 47p. Chassis sockets 42p. Elbows PL259/SO239 90p. Double in line male connector (2XPL259) 65p. Plug reducers 13p. PL259 Dummy load, 52 ohms 1 watt with indicator bulb 95p.</p>	<p><b>TAPE HEADS</b> Mono cassette £1.75. Stereo cassette £3.90. Standard 8 track stereo £1.95. BSR MN1330 1/2 track 50p. BSR SRP90 1/2 track £1.95. TD10 tape head assembly — 2 heads both 1/2 track R/P with built in erase, mounted on bracket £1.20.</p>
<p><b>MULTIMETERS</b> NH55 2,000 o.p.v. IKV AC/DC. 100ma DC current, 2 resistance ranges to 1meg. £5.95. MODEL 72606 20,000 opv 1,000 volts AC/DC., 250ma DC current, resistance 3 ranges to 3meg, dimensions 127 x 90 x 32mm, mirror scale £11.75p. HANSEN AT210 100,000 opv 1.2KV AC/DC., 12 amps AC/DC current, resistance to 200 meg in 4 ranges, capacitance 200pf-0.2mfd, 1.00pf-lmfd., decibel range, internal safety fuse, dimensions 160 x 105 x 50mm, an excellent meter, £34.50p.</p>	<p><b>RIBBON CABLE</b> 8 way single strand miniature 22p per metre.</p>	<p><b>TELEPHONE PICK UP COIL</b> Sucker type with lead and 3.5mm plug 62p.</p>	<p><b>BUZZERS</b> MINIATURE SOLID STATE BUZZERS, 33 x 17 x 15mm white plastic case, output at three feet 70db (approx), low consumption only 15mA, four voltage types available, 6-9-12 or 24VDC, 80p each. LOUD 12VDC BUZZER, Cream plastic case, 50mm diam. x 30mm high 63p. GPO OPEN TYPE BUZZER, adjustable works 6-12VDC 27p. 12VDC siren, all metal rotary type, high pitched wail, £7.50.</p>	<p><b>TERMS:</b> Cash with Order (Official Orders welcomed from colleges etc). 30p postage please unless otherwise shown. VAT inclusive. S.a.e. for illustrated lists.</p>
<p><b>MORSE KEYS</b> Beginners practice key £1.05. All metal fully adjustable type. £2.60.</p>	<p><b>SPEAKER BARGAINS</b> All 8 ohms impedance 7" x 4" 4 watts £1.95, 6" round 5 watts £1.75, 8" round 6 watts, twin cone, £2.95. 10" round 6 watts, twin cone, £3.45.</p>	<p><b>RELAYS</b> Plastic Encap. Reed Relay, 0.1 matrix, 1kΩ coil, 9-12VDC normally open, 35p. Miniature encapsulated reed relay 0.1 matrix mounting, single pole make, operates on 12VDC 50p each. Continental series, sealed plastic case relays, 24VDC 3pole change over 5 amp contacts, new 65p. Min. sealed relay, P.C. mounting, 6-9vdc operation changeover 3 amp contacts, new 85p. Metal Cased Reed Relay, 50 x 45 x 17mm, has 4 heavy duty make reed inserts, operates on 12VDC 35p each. Magnets 1 1/2" long 1/4" thick with fixing hole, 10 for 40p.</p>	<p><b>STEREO FM/GRAM TUNER AMPLIFIER CHASSIS, VHF and AM. Bass, treble and volume controls, Gram. 8-track inputs, headphone output jack, 3 watts per channel with power supply. £14.95 and £1.20 p&amp;p (CCT supplied).</b></p>	<p><b>STEREO FM/GRAM TUNER AMPLIFIER CHASSIS, VHF and AM. Bass, treble and volume controls, Gram. 8-track inputs, headphone output jack, 3 watts per channel with power supply. £14.95 and £1.20 p&amp;p (CCT supplied).</b></p>
<p><b>MINIATURE LEVEL METERS</b> 1 Centre Zero 17 x 17mm 75p. 2 (scaled 0-10) 28 x 25mm 75p. 3 Grundig 40 x 27mm £1.25.</p>	<p><b>STEREO FM/GRAM TUNER AMPLIFIER CHASSIS, VHF and AM. Bass, treble and volume controls, Gram. 8-track inputs, headphone output jack, 3 watts per channel with power supply. £14.95 and £1.20 p&amp;p (CCT supplied).</b></p>	<p><b>DALO 33PC Etch Resist printed circuit maker pen, with spare tip, 79p.</b></p>	<p><b>STEREO FM/GRAM TUNER AMPLIFIER CHASSIS, VHF and AM. Bass, treble and volume controls, Gram. 8-track inputs, headphone output jack, 3 watts per channel with power supply. £14.95 and £1.20 p&amp;p (CCT supplied).</b></p>	<p><b>STEREO FM/GRAM TUNER AMPLIFIER CHASSIS, VHF and AM. Bass, treble and volume controls, Gram. 8-track inputs, headphone output jack, 3 watts per channel with power supply. £14.95 and £1.20 p&amp;p (CCT supplied).</b></p>
<p><b>JVC NIVICO STEREO CASSETTE MECHANISM. Music centre type. Rev. counter, remote operation £13.50 and £1.00 p&amp;p.</b></p>	<p><b>STEREO FM/GRAM TUNER AMPLIFIER CHASSIS, VHF and AM. Bass, treble and volume controls, Gram. 8-track inputs, headphone output jack, 3 watts per channel with power supply. £14.95 and £1.20 p&amp;p (CCT supplied).</b></p>	<p><b>STEREO FM/GRAM TUNER AMPLIFIER CHASSIS, VHF and AM. Bass, treble and volume controls, Gram. 8-track inputs, headphone output jack, 3 watts per channel with power supply. £14.95 and £1.20 p&amp;p (CCT supplied).</b></p>	<p><b>STEREO FM/GRAM TUNER AMPLIFIER CHASSIS, VHF and AM. Bass, treble and volume controls, Gram. 8-track inputs, headphone output jack, 3 watts per channel with power supply. £14.95 and £1.20 p&amp;p (CCT supplied).</b></p>	<p><b>STEREO FM/GRAM TUNER AMPLIFIER CHASSIS, VHF and AM. Bass, treble and volume controls, Gram. 8-track inputs, headphone output jack, 3 watts per channel with power supply. £14.95 and £1.20 p&amp;p (CCT supplied).</b></p>

# PROGRESSIVE RADIO

31 CHEAPSIDE, LIVERPOOL 2.

ALL ORDERS DESPATCHED BY RETURN POST





# IT'S HAPPENED AGAIN!

## THE PART THREE CATALOGUE IS PUBLISHED & WE HAVE MOVED TO BIGGER PREMISES.

Yes, it's here at last - the all new Part Three Catalogue. Fun for all the family, and the usual update on all that is new, worthwhile and exciting in the world of Radio and Communications. A big section on frequency synthesis techniques covering broadcast tuners, to communication quality transmitter systems. More new products than ever - RADIO CONTROL parts, crystal filters, ceramic filters for 455kHz and the new range of TOKO CFSH low temperature coefficient types for 10.7MHz. Details on new radio ICs, including the new HA11225, the CA3189E lookalike with 84dB signal to noise, and adjustable muting threshold. Radio control ICs - and an updated version of the RCM&E 8 channel FM receiver - now with an Ambit designed screened front end, with 27MHz ceramic bandpass filter. LCD panel clock/timer modules - the neatest and best LCD panel DVM yet (only £19.45 each + VAT), the new 5 decade resolution DFM3 for LW/HF/VHF with LCD readout. The DFM6 with fluorescent display to 10kHz resolution on VHF, 1kHz on SW. A 1kHz HF synthesiser with five ICs - the list is endless. Get your copy of the catalogue now. Post publication price is 60p (inc PP etc). The previous two sections are also required for a complete picture: Parts 1 & 2, £1 the pair, All 3 £1.50. And don't miss our spot the gibbon contest, together with a quiz to see if you can spot the differences between a neolithic cave drawing and a circuit diagram of one of our competitor's tuners. (\* Yes, we still haven't learnt how to spell.)

### FM radio control RX kit

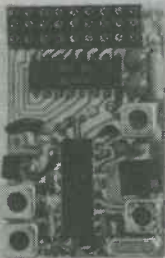

- 8 Channel RC receiver (FM)
- Single IC RF/IF/Detector
- Single IC decoder
- 27MHz ceramic filter input
- FET RF stage with double tuned bandpass filter
- Dual ceramic filter IF
- Best quality SLM servo connector block
- ONLY £16.10 inc VAT (kit) (includes new SLM case)

New series of radio modules in fully screened cans:

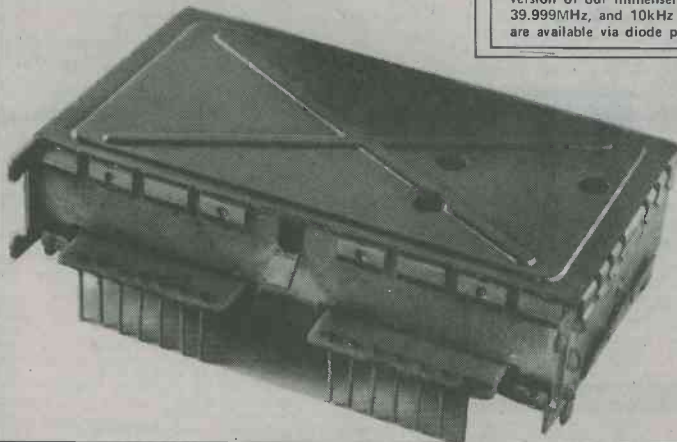

- There is a danger - when advertizing in some magazines - that because we do not find space to list everything we sell in every ad., that some readers forget about half the ranges we stock. So to summarize the general ranges:
- TOKO Chokes, coils for AM/FM/SW/MPX, Audio filters etc
- Filters: Ceramic for AM/FM, LC for FM, MPX etc.
- Polyvaricons
- ICs for radio, clock LSI, radio control, MPX decoders etc
- Micrometals Dust iron cores for toroids for resonant and EMI filters
- Toroid mounts
- Hitachi Radio/audio/mpx linear ICs
- 100W MOSFETs, small signal FETs, MOSFETs and bipolar

- And the following groups of products from a broad range of sources:
- Semiconductors - specializing in radio devices, Plessey SL1600, EUROPE's best selection of AM/FM and communications devices. Power MOSFETs, WORLD's LOWEST NOISE AUDIO small signal transistors, BAR graph LED drivers for linear and log.
- CD4000 series CMOS, TTL/LPSNTTL, standard linears (741, 301, 3080 etc). MPUs, memories.
- Small signal transistors from AEG BC237/8/9 families etc. (1000 off BC239C : 5.2p ea)
- LEDs: AEG 3mm/5mm round, 2.5x5mm flat, red, green, orange, yellow. The best prices you will find for quality products.
- MOSFETs for RF signal processing, including the 3F960 UHF device, and 3SK51 for VHF.
- Varicap diodes for 17:1 capacity ratio tuning

### DOES YOUR ONE GLOW GREEN IN THE DARK ??

Our DFM4 does, since it uses a vacuum fluorescent display for direct readout of MW/LW/FM. Basically the same as the DFM2, (LCD Version). £24.45 kit (inc VAT) Transformer with all necessary windings for DFM4 - £2.50 inc VAT.

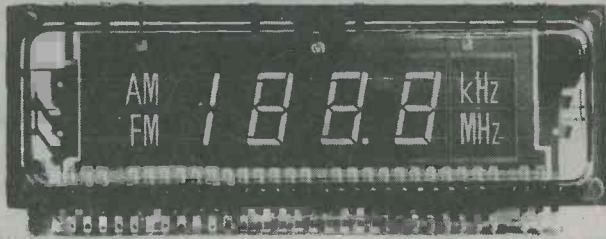

Not illustrated here - but also now available is the DFM6. This is a vacuum fluorescent display version of our immensely popular DFM3 (LCD). Resolution is 100Hz to 3.9999MHz, 1kHz to 39.999MHz, and 10kHz to 200.00MHz; all standard IF offsets (inc. 10.7MHz on shortwave) are available via diode programming.

### UM1181 VHF band 2 VARICAP TUNERHEAD

5 tuned circuit, with image/spurri better than -80dB, buffered LO output, MOSFET RF stage, FET IF preamp, tunes with only 1% to 8v, -9dBm 3rd order intercept. 1off price £12.00 inc VAT. (100off) O/A

911225 FM IF strip with all mod cons for the HiFi tuner: All types use 80dB S/N Hitachi IC, with muting, AFC, AGC, meter outputs for signal level and centre zero. IF preamp stage.

'A' Dual linear phase ceramic filters, with MOSFET (AGC'd) IF preamp and a 3rd narrow filter with OC filter selection. Dual tuned FM detector stage. £23.95 inc VAT (built)

'B' Dual ceramic filters, single tuned detector stage £14.95 inc VAT (All 'A' series units are set up with a spectrum analyzer for best THD)

### 91072 AM RADIO TUNER MODULES - DC TUNED AND DC SWITCHED Available February '80

All include buffered LO output, mechanical IF filter (TOKO CFMO) 110v tuning bias, switching by a single pole to earth

A MW/LW (150 to 350kHz LW range) with ferrite rod antenna

B As 'A' but also including SW1 or SW2 (specify.)

SW1 = 1.8 to 4MHz SW2 = 5 to 10MHz

C With both SW ranges

Prices -one off INC VAT

'A' £14.43 'B' £15.90 'C' £17.50 (Custom types O/A)

FREQUENCY READOUT LSI from OKI, with a one-chip answer to most digital frequency display needs (and various modules).

Crystal and ceramic ladder filters from leading manufacturers, ferrite rods, various ferrite beads and a range of crystals for standard frequencies and both AM and FM radio control at 27MHz. Trimmer capacitors.

METERS - a new range of linear movement types, plus many 'indicator' types for VU, all types of tuning indicators etc.

SOCKETS - a new range that are better quality than Texas low profile, yet better priced.

Modules for AM/FM/STEREO, complete kits for tuners, audio amplifiers from Larholt.

SWITCHES - complete low cost DIY systems for push button arrays, keyboard switches.

DOUBLE BALANCED MIXERS - MCL SBL1, replacement for MD108 etc. And cheaper.

OUR LATEST MOVING EXPERIENCE :: At last, we have moved to the address below. There is car parking for customers approaching via North Service Road (an extension of North Road Avenue, entrance opposite the Brentwood Fire Station.) Pedestrian access from the High Street (alongside 117 High Street). The new building is six times bigger than our Gresham Road offices, and we will be installing a much expanded sales counter in the fullness of time. NEW TELEPHONE NUMBER (0277) 230909, TELEX NUMBER (as before) 995194 AMBIT G. See you there!

# 200 North Service Road, Brentwood, Essex.



## THE MODERN BOOK CO

### UNDERSTANDING MICROPROCESSORS Texas Ins. £4.25

For the newcomer to Microprocessors. An in-depth look at the magic of the solid-state chips that are affecting our lives. Written in everyday language. Ideal for self-paced individualised learning.

<b>ELECTRONIC PROJECTS IN THE HOME</b> by O. Bishop	Price £2.50	<b>THEORY &amp; PRACTICE OF MODEL RADIO CONTROL</b> by P. Newell	Price £4.50	<b>UNDERSTANDING SOLID-STATE ELECTRONICS</b> by Texas Inst.	Price £1.80
<b>ELECTRONIC PROJECTS IN AUDIO</b> by R. A. Penfold	Price £2.50	<b>REPAIRING POCKET TRANSISTOR RADIOS</b> by I. R. Sinclair	Price £2.55	<b>A SIMPLE GUIDE TO HOME COMPUTERS</b> by S. Ditlea	Price £4.00
<b>OP-AMPS THEIR PRINCIPLES &amp; APPL.</b> by J. B. Dance	Price £2.50	<b>MAKING &amp; REPAIRING TRANSISTOR RADIOS</b> by W. Oliver	Price £2.30	<b>HOW TO BUILD A COMPUTER-CONTROLLED ROBOT</b> by T. Loofbourrow	Price £5.30
<b>PRINTED CIRCUIT ASSEMBLY</b> by M. J. Hughes	Price £2.10	<b>WORLD RADIO TV HANDBOOK</b> by J. M. Frost	Price £9.25	<b>THE CATHODE-RAY OSCILLOSCOPE &amp; ITS USE</b> by G. N. Patchett	Price £4.00
<b>ELECTRONIC SECURITY DEVICES</b> by R. A. Penfold	Price £1.65	<b>PROJECTS IN RADIO &amp; ELECTRONICS</b> by I. R. Sinclair	Price £2.50	<b>HOW TO GET THE BEST OUT OF YOUR TAPE RECORDER</b> by P. J. Guy	Price £1.90
<b>UNDERSTANDING DIGITAL ELECTRONICS</b> by Texas Inst.	Price £4.00	<b>ELECTRONIC PROJECTS IN THE HOME</b> by O. Bishop	Price £2.50	<b>A GUIDE TO AMATEUR RADIO</b> by P. Hawker	Price £1.70
<b>UNDERSTANDING MICRO-PROCESSORS</b> by Motorola	Price £4.30	<b>SIMPLE CIRCUIT BUILDING</b> by P. C. Graham	Price £2.20	<b>RADIO CONSTRUCTION FOR AMATEURS</b> by R. H. Warring	Price £2.80
<b>THE FIRST BK OF MICROCOMPUTERS</b> by R. Moody	Price £3.35	<b>110 SEMICONDUCTOR PROJECTS FOR THE HOME CONSTRUCTOR</b> by R. M. Marston	Price £5.20	<b>MAKING TRANSISTOR RADIOS A BEGINNER'S GUIDE</b> by R. H. Warring	Price £2.90
<b>HOW TO BUILD YOUR OWN SOLID STATE OSCILLOSCOPE</b> by F. G. Rayer	Price £1.70	<b>HAM RADIO</b> by K. Ulyett	Price £5.00		
<b>THE OSCILLOSCOPE IN USE</b> by I. R. Sinclair	Price £2.85				

We have the Finest Selection of English and American Radio Books in the Country ☆ PRICES INCLUDE POSTAGE ☆

**19-21 PRAED STREET (Dept RC) LONDON W2 1NP**

Telephone: 01-402 9176

# Now, the hand-held 50MHz counter.

**For £54.00**  
+15% VAT AND P&P. £63.83

Various accessories are also available.

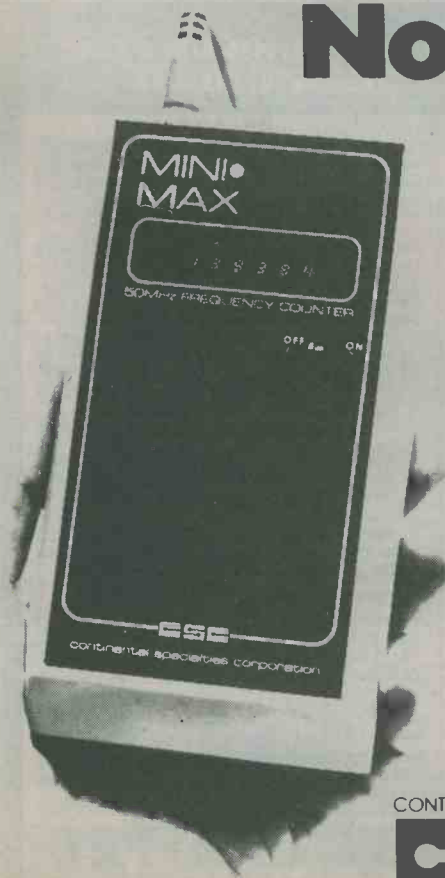

It's true. Our new, diminutive frequency counter, the \*Max 50 costs a mere £54.00. Which, when you consider its totally, automatic performance, is quite outstanding.

Well, what would you normally expect to pay for a guaranteed frequency range of 100Hz to 50MHz; 6-digit LED display; auto-ranging, polarity, slope trigger and input level; and built-in overvoltage protection?

And there's even more. The high reliability of LSI circuitry; sensitivity of 30MV trigger threshold; 3ppm accuracy; choice of battery or a.c. mains operation, and optional antenna.

True value, and yours for the asking.

Just call us on Saffron Walden (0799) 21682 right away. Your own \*Max 50 could be hand-held tomorrow!

Dealer enquiries also welcomed. \*For a while, supplies will be labelled 'Mini-max'.

CONTINENTAL SPECIALTIES CORPORATION C.S.C. (UK) Limited  
Dept 16F Unit 1, Shire Hill Industrial Estate  
Saffron Walden Essex CB11 3AQ  
Telephone Saffron Walden (0799) 21682  
Telex 817477



# LATEST BOUND VOLUME No. 32

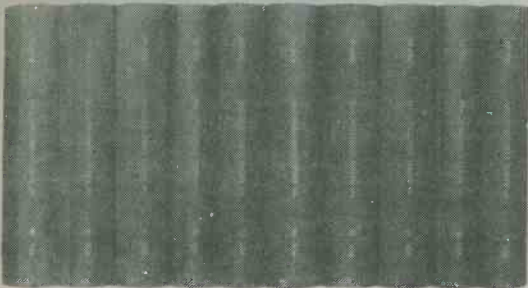

## of "Radio & Electronics Constructor"

Comprising  
776 pages  
inc. index

SEPTEMBER 1978  
to AUGUST 1979

PRICE £5.50 P&P £1.05

BOUND VOLUME No. 27 (August 1973 to July 1974)  
BOUND VOLUME No. 28 (August 1974 to July 1975)  
BOUND VOLUME No. 29 (August 1975 to July 1976)  
BOUND VOLUME No. 30 (August 1976 to July 1977)  
BOUND VOLUME No. 31 (August 1977 to August 1978)

PRICE £3.00 p&p £1.05  
PRICE £3.20 p&p £1.05  
PRICE £3.50 p&p £1.05  
PRICE £3.70 p&p £1.05  
PRICE £5.20 p&p £1.05

We regret all other volumes are now completely sold out.

Available only from:

DATA PUBLICATIONS LTD., 57 MAIDA VALE, LONDON W9 1SN

## ELONHURST LIMITED

104A BRACKENBURY ROAD · LONDON W6

Telex: 9854665 GITS G ELECT

Telephone: 01-748 5778

NUTS & BOLTS	FERRITE POT CORES	RELAYS
50 x asstd 4BA bolts 40p 50 x asstd 6BA bolts 35p 40 x 4BA nuts 38p 40 x 6BA nuts 32p 50 x 4BA solder tags 22p 50 x 6BA solder tags 22p 50 x 4BA plain washers 20p 50 x 6BA plain washers 20p 20 x asstd 4BA and 6BA nylon nuts and bolts 45p	FX1142 type complete with bobbin, new ex-equipment, the bobbins require unwinding. A real snip at 40p.  <b>I.C. SOCKETS</b> We are clearing all our stocks of low profile i.c. sockets. 8 pin two for 13p 14 pin two for 15p 16 pin two for 17p <i>Limited stocks only!</i>	12v coil single pole changeover miniature cased type 65p. 12v coil two pole changeover open type 75p. 24v coil three pole sealed 60p.  <b>TRIMMERS</b> These are all new, modern types. Beehive trimmer 3 to 30pf 14p. Miniature 1.5 to 2.5pf 18p. Miniature 3 to 15pf 18p. Compression 10pf 16p. 30pf 16p. 50pf 16p.
PANEL INDICATORS	TRANSISTOR COVERS	WIREWOUND POTS
Round neon types 250v wkg screw terminals, requires 14mm hole, push in and it grips panel firmly, these are brand new and very smart. Red 34p. Amber 35p. Clear 34p. Green 36p. Round miniature neon types 240v wkg wire leads, requires 8mm panel hole, push in and fix with supplied bush. Red 45p. Amber 45p.	These are black nylon covers to insulate TO3 transistors, push fit. Six for 18p.	All new modern types. 2K 2 watt 32p. 10K 2 watt 32p. 5K 4 watt 34p. 100K 4 watt 34p.
BRIDGE RECTIFIERS	CABLE TIES	20 watt INVERTER KIT
50piv 1 amp miniature 40p 100piv 500ma miniature 35p 200piv 1 amp miniature 44p 800piv 1 amp miniature 48p 200piv 1.6 amp 52p	Nylon type with non-release ratchet action, 3½" long, suitable for fixing together wiring, cables, etc. Ten for 22p.	A genuine bargain which we are prepared to guarantee your delight, we supply all components: transistors, resistors, nuts and bolts, instrument case to let you build the basic unit, also circuit diagram supplied. The inverter requires 12v dc in 230v AC output at approx 44Hz square wave. £5.50.
ROTARY POTS	PLASTIC FEET	WIREWOUND RESISTORS
We have a large stock of these surplus to our normal ranges, to clear as mixed bags of asstd. values and sizes, all are brand new and modern. Ten pots for £1.00.	These are white square self adhesive backed feet for use on instrument cases etc. 12.5mm. Six for 20p.	All new modern types: 56 ohm 7w, 75 Ω 5w, 500 ohm 5w, 560 ohm 5w, 680Ω 5w, 1k 15w, 1k2 5w, 2k2 10w, 2k7 5w, 6k8 5w. All at six for 20p.
TERMS OF BUSINESS:	MAINS SUPPRESSOR	HOLDER
We guarantee to forward goods within 7 days of receipt of order. No credit notes issued we send a refund if goods are out of stock. Minimum order charge of £1.50. All goods post paid U.K. only.	Designed for use with small electric motors etc, rated at 250v AC 75p.	This is a nylon battery cage to take 4 x HP7 batteries 12p.
	FUSEHOLDERS	BUSHES
	These are all new modern types. 1¼" inline nylon 18p. 200mm panel mounting 34p.	Nylon insulating bushes for mounting TO3 transistors. Ten for 22p.

**ELONHURST LIMITED**  
104A BRACKENBURY ROAD · LONDON W6



**CMOS**

4020	50p	4050	25p
4022	50p	4060	80p
4023	13p	4066	30p
4024	40p	4068	13p
4001	13p	4025	13p
4002	13p	4026	90p
4007	13p	4027	28p
4009	30p	4028	45p
4011	13p	4029	50p
4012	13p	4040	55p
4013	28p	4041	55p
4015	50p	4042	55p
4016	28p	4043	50p
4017	47p	4046	90p
4018	55p	4049	25p

FULL DETAILS IN CATALOGUE!

**TTL**

7473	20p	74141	55p
7474	22p	74145	55p
7475	25p	74148	90p
7401	10p	7476	20p
7402	10p	7485	55p
7404	12p	7486	20p
7406	22p	7489	135p
7408	12p	7490	25p
7410	10p	7492	30p
7413	22p	7493	25p
7414	39p	7494	45p
7420	12p	7495	35p
7427	20p	7496	45p
7430	12p	74121	25p
7432	18p	74122	35p
7442	38p	74123	38p
7447	45p	74125	35p
7448	50p	74126	35p
7454	12p	74132	45p

**OPTO**

LED's	0.125in.	0.2in	each	100
Red	TIL209	TIL220	9p	7.5p
Green	TIL211	TIL221	13p	12p
Yellow	TIL213	TIL223	13p	12p
Clips	3p	3p		

DISPLAYS

DL704	0.3 in CC	130p	120p
DL707	0.3 in CA	130p	120p
FND500	0.5 in CC	100p	80p

**SKTS**

Low profile by Texas



8pin	8p	18pin	14p	24pin	18p
14pin	10p	20pin	16p	28pin	22p
16pin	11p	22pin	17p	40pin	32p

3 lead T018 or T05 socket. 10p each  
Soldercon pins: 100:50p 1000:370p

**PCBS**

**VEROBOARD**

Size in.	0.1in	0.15in.	Vero	Cutter 80p
2.5 x 1	14p			
2.5 x 3.75	45p	45p		
3.75 x 5	54p	54p		
3.75 x 5	64p	64p		
3.75 x 17	205p	185p		

Single sided pins per 100 40p 40p  
Top quality fibre glass copper board. Single sided. Size 203 x 95mm. 60p each  
'Dalo' pens. 75p each  
Five mixed sheets of A1fac. 145p per pack

**RESISTORS**

Carbon film resistors. High stability, low noise 5%.

E12 series. 4.7 ohms to 10M. Any mix:

0.25W	each	100+	1000+
0.5W	1p	0.9p	0.8p
	1.5p	1.2p	1p

Special development packs consisting of 10 of each value from 4.7 ohms to 1 Meg-ohm (650 res) 0.5W £7.50. 0.25W £5.70.

**METAL FILM RESISTORS**

Very high stability, low noise rated at 1/4W 1%. Available from 51ohms to 330k in E24 series. Any mix:

0.25W	each	100+	1000+
	4p	3.5p	3.2p

PLEASE WRITE FOR YOUR FREE COPY OF OUR 80 PAGE CATALOGUE OF COMPONENTS. OVER 2500 ITEMS LISTED.



**LINEAR**

THIS IS ONLY A SELECTION!

LF356	80p	NE531	98p
LM301AN	26p	NE555	23p
LM308	60p	NE556	60p
LM318N	75p	NE567	100p
LM324	45p	RC4136	100p
LM339	45p	SN76477	230p
LM378	230p	TBA800	70p
LM379S	410p	TBA810S	100p
LM380	75p	TDA1022	620p
LM3900	50p	TL081	45p
LM3909	65p	TL084	125p
LM3911	100p	ZN414	80p
MC1458	32p	ZN425E	390p
MM57160	590p	ZN1034E	200p

**TRANSISTORS**

AC127	17p	BCY72	14p	ZTX500	16p
AC128	16p	BD131	35p	2N697	12p
AC176	18p	BD139	35p	2N3053	18p
AD161	38p	BD140	35p	2N3054	50p
AD162	38p	BFY50	15p	2N3442	135p
BC107	8p	BFY51	15p	2N3702	8p
BC108	8p	BFY52	15p	2N3703	8p
BC108C	10p	MJ2955	98p	2N3704	8p
BC109	8p	MPSA06	20p	2N3705	9p
BC109C	10p	MPSA56	20p	2N3706	9p
BC147	7p	TIP29C	60p	2N3707	9p
BC148	7p	TIP30C	70p	2N3708	8p
BC177	14p	TIP31C	65p	2N3819	15p
BC178	14p	TIP32C	80p	2N3820	44p
BC179	14p	TIP2955	65p	2N3904	8p
BC182	10p	TIP3055	55p	2N3905	8p
BC182L	10p	ZTX107	14p	2N3906	8p
BC184	10p	ZTX108	14p	2N4058	12p
RC184L	10p	ZTX300	16p	2N5457	32p
BC212	10p			2N5459	32p
BC212L	10p			2N5777	50p
BC214	10p				
BC214L	10p				
BC477	19p	1N914	3p	1N4006	6p
BC478	19p	1N4001	4p	1N5401	13p
BC548	10p	1N4002	4p	BZY88	8p
BCY70	14p	ITT Full spec product			
BCY71	14p	1N4148	£1 40 100		

**DIODES**

**CAPACITORS**

**TANTALUM BEAD**

0.1, 0.15, 0.22, 0.33, 0.47, 0.68, 1 & 2.2uF @ 35V

4.7, 6.8, 10uF @ 25V

22 @ 16V, 47 @ 6V, 100 @ 3V

**MYLAR FILM**

0.001, 0.01, 0.022, 0.033, 0.047, 0.068, 0.1

**POLYESTER**

Mullard C280 series

0.01, 0.015, 0.022, 0.033, 0.047, 0.068, 0.1, 5p

0.15, 0.22 7p

0.33, 0.47 10p

0.68 14p

1.0uF 17p

**CERAMIC**

Plate type 50V. Available in E12 series from 22pF to 1000pF and E6 series from 1500pF to 0.047uF

**RADIAL LEAD ELECTROLYTIC**

63V	0.47	1.0	2.2	4.7	10	5p
			22	33	47	7p
						13p
						20p
25V	10	22	33	47		5p
						8p
						10p
						15p
						23p

**CONNECTORS**

**JACK PLUGS AND SOCKETS**

2.5mm	unscreened	screened	socket
3.5mm	9p	13p	7p
Standard	9p	14p	8p
Stereo	16p	30p	15p
	23p	36p	18p

**DIN PLUGS AND SOCKETS**

	plug	chassis socket	line socket
2pin	7p	7p	7p
3pin	11p	9p	14p
5pin 180°	11p	10p	14p
5pin 240°	13p	10p	16p

**1mm PLUGS AND SOCKETS**

Suitable for low voltage circuits, Red & black. Plugs. 6p each Sockets: 7p each.

**4mm PLUGS AND SOCKETS**

Available in blue, black, green, brown, red, white and yellow. Plugs: 11p each Sockets: 12p each

**PHONO PLUGS AND SOCKETS**

Insulated plug in red or black 9p

Screened plug 13p

Single socket 7p Double socket 10p

# STEVENSON

## Electronic Components

**SPECIAL OFFERS**

A range of special offer items valid during February. All orders placed for these items must be received during February.

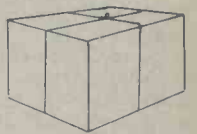

Pack of 3 x LM380	225p	200p
Pack of 30 x 1N4001	120p	100p
Pack of 4 x FND500	400p	350p
Pack of 15 x 2N3702	120p	100p
Pack of 15 x BC107	120p	100p

Special pack of nuts + bolts containing over 600 4BA + 6BA nuts, bolts and washers 330p 250p

Pack of 4 red + 4 black crocodile clips 64p 50p

Mixer control knobs, per 100 (mixed) colours to suit 1400p 1300p

**MULTIMETERS**

A really smart looking multimeter with an impressive specification for such a small size. The very clean scale in white and green on a black background makes this meter very easy to read. The D.C. Impedance of this meter is 4K ohms per volt which is exceptionally good compared with the vast majority of multimeters of a similar size. £5.95 each.

**SPECIFICATION**

DC Volts 5V 25V 250V 500V (4K ohms/V)

AC Volts 10V 50V 500V 1000V (2K ohms/V)

DC Current 250uA 250mA

Resistance 0 - 600K (7K ohms centre)

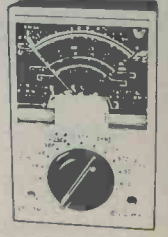

**PANEL METERS**

High quality 2" wide view meters. Zero adjustment. Back illumination wiring. Available in 50 uA, 100 uA, 500 uA, 1mA, 100mA, 500mA, 1A. £4.95 ea. VU meter similar style. £1.50 ea.

**SLIDE POTENTIOMETERS**

Good quality 60mm travel slider with 80mm fixing centres. Available from 5k - 500K in log and linear. 55p each. Suitable black knobs 6p ea. Coloured knobs 10p ea.



We now offer one of the widest ranges of components at the most competitive prices in the U.K. See catalogue for full details. We welcome callers at our shop in College Rd, Bromley, from Mon-Sat, 9am-6pm (8pm on Weds and Fridays). Special offers always available. We also provide an express telephone order service. Orders received before 5pm are shipped same day. Contact our sales office now with your requirements. TELEPHONE: 01-464 2951/5770.

Quantity discounts on any mix TTL, CMOS, 74LS and Linear circuits: 100+ 10%, 1000+ 15%. Prices VAT inclusive. Please add 50p for P & P, no charge for orders over £15. Official orders welcome. All prices valid to April 1980.



BARCLAYCARD & ACCESS WELCOME.



Mail orders to: STEVENSON (Dept RE)

# 76 College Road, Bromley, Kent BR1 1DE.

# TRADE COMPONENTS

**PAY A VISIT — THOUSANDS MORE ITEMS BELOW WHOLESALE PRICE. CALLERS PAY LESS ON MANY ITEMS AS PRICES INCLUDE POSTAGE. PRICES INCLUDE VAT AND ADDITIONAL DISCOUNT IN LIEU OF GUARANTEE. GOODS SENT AT CUSTOMERS RISKS UNLESS SUFFICIENT ADDED FOR REGISTRATION OR COMPENSATION FEE POST. CORRECT AT 28/12/79.**

## CARTERS MINIMITE SIREN

12/24V £6 for alarms etc.

### VALVE BASES

Printed circuit B/G	7p
Chassis B7-B7G	11p
Shrouded Chassis B7G-B8A	13p
B12A tube. Chassis B9A	13p

Speaker 6" x 4" 5 ohm ideal for car radio	£1.00
4 1/2" diam. 30 Ω	£1.75
4" diam. 80	£1.00
2 1/2" diam. 8 Ω 75p	or 32
4 1/2" diam. 80	£1.07

<b>TAG STRIP</b>	5 x 50pF or 1000 +
9-way 4 1/2p Single 2p	300pF trimmers 35p

C30 Cassette Pre-Programmed TRS80 Electric Pencil 25p or Record/Play

Car type panel lock and key 65p  
Transformer 9V 4A £3.30

**Aluminium Knobs** for 1/4" shaft. Approx. 1000 x 7/8" with indicator Pack of 5 95p

JAP 4 gang min. sealed tuning condensers 40p

## ELECTROLYTICS — Hundreds more in catalogue Value/Voltage

Tant Bead .22. 47/35v 6p. 1. 1/35v. 47/6.3v 8p. 22/20v. 3.3/16v. 4.7/35v. 10/25v. 22/16v 9p. 4.7/16v. 10/3v 10p. 3.3/35v 12p.

### Wire End

63v 2.2, 3 1/2p. 4.7, 4p. 10, 33, 5p. 2.5 3p. 1.5, 22 47 6p. 68, 100, 220 8p. 150 7 1/2p. 330 9p. 470 17 1/2p. 1000 29p. 25v 6, 6.4, 10, 12, 16, 22, 25, 30, 33, 40, 47, 50, 64 4p. 100, 150, 160, 330 6p. 220 7p. 250, 300, 470 8p. 1000 11 1/2p. 22/16. 3.3/50, 10/50 4p. 100/10, 47/16 5p. 100/16 100/35, 220/16 6p. 470/6.3, 10/350 470/16 8p. 1000/16 10p. 1500/6.3 7 1/2p. 2200/10 20p. 4700/10 30p. 15/160 7p. CANS 250/300, 45p. 300/450 90p. 100/275 14p. 2000/100 82p. 1000/100 70p. 8+8/450 9p. 10,000/16 36p. 2000/50 35p. 2000 + 2000/50 40p. Full range in catalogue.

**BOXES** — Grey polystyrene 61 x 112 x 31mm, top secured by 4 self tapping screws 57p clear perspex sliding lid, 46 x 39 x 24 mm 10p

**ABS**, ribbed inside 5mm centres for P.C.B., brass corner inserts, screw down lid, 50 x 100 x 25mm orange 65p; 80 x 150 x 50mm black 97p; 110 x 190 x 60mm black £1.52.

**DIECAST ALI** superior heavy gauge with sealing gasket, approx 6 1/2" x 2 3/8" x 1 1/8" £1.55; 3 1/2" x 2 3/8" x 1 1/8" 99p.

**VARIABLE CAMM PROGRAMMER** 10, 12 or 15 pole 2 way, 50VAC motor — series with 1mfd, or 3k 10W or 15W pygmy bulb for mains operation. Ex equipment £3.10.

Pole	Way	Type	
1	2	Flush Wall Wh. Rocker	35p
6	2	Slide	24p
2	1	Rotary Mains	14 1/2p
2	Alternating	Micro with roller	30p
4	2	Centre off 15A 250V	
		A.C. Toggle	£1.20
2	1	Toggle	40p
1	2	Sub-Min Toggle	67p
2	Alternating	2A Mains Push (1/2" hole)	43p
1	3	Slide	12p

S.P.S.T. 10 amp 240v. white rocker switch with neon. 1" square flush panel fitting 39p

1 pole 2-way 10 amp oblong clip in mains rocker appliance switch 36p

Standard thumb-wheel switch 0-9 in 1248N or B.C.D. or Comp. 1242 also 2p co 86p

Standard Lever key switch D.P.D.T. locking plus D.P.D.T. and S.P.S.T. Heavy Duty non latching 73p

1 pole 2-way Micro; roller, lever or hair trigger 19p button 15p

Push to make 15p To break 17p

4-bank of 2PCO independent 40p

5-bank of 2x2PCO, 4PCO, 6PCO, interlock plus 2PCO independent 48p

6-bank of 4x4PCO+6PCO+2PCO interlocking 58p

**COMPUTER & AUDIO BOARDS/ASSEMBLIES**  
VARYING CONTENTS INCLUDE ZENER, GOLD BOND, SILICON, GERMANIUM, LOW AND HIGH POWER TRANSISTORS AND DIODES, HI STAB RESISTORS, CAPACITORS, ELECTROLYTICS, TRIMPTS, POT CORES, CHOKES, INTEGRATED CIRCUITS, ETC.

3lb for £2.30 7lb for £4.30

1k horizontal preset with knob 10 for 40p	3" Tape Spools 5p
	1" Terry Clips 5p
	12 Volt Solenoid 40p

ENM Ltd. cased 7-digit counter 2 1/2" x 1 1/2" x 1 1/2" approx. 12V d.c. (48 a.c.) or mains £1.10

Auto charger for 12v Nicads, ex-new equipment £3.95

Miniature 0 to 5mA d.c. meter approx 7/8" diameter £1.25

RS Yellow Wander Plug Box of 12 £40p

18 SWG multicore solder 3 1/2p foot

**SAPHIRE STYLII**. 10 different; dual and single point, current and hard to get types. My mix £1

**BRIAN J. REED** ESTABLISHED 23 YEARS  
161 ST. JOHNS HILL, BATTERSEA, LONDON SW11 1TQ  
Open 10 a.m. till 7 p.m. Tuesday to Saturday. VAT receipts on request.  
Terms: Payment with order Telephone: 01-223 5016

## RESISTORS

1/4-1/2 watt 1 1/2p 10 same value 10p  
1 watt 1 1/2p  
1 or 2% 1 1/2p  
Up to 15W w/wound 10p. 10 same value 75p

**RELAYS**  
RS/Alma reed relay, 1K12v or 3k Ω 18-30v d.c. coil, normally open 38p  
12v d.p.c.o. heavy duty octal £1  
600 Ω 4 p/co min sealed 75p. Base 10p. D.I.L. 3.7-12V S.P. £1.00

## POTS

Wirewound 38p. Log or Lin rotary 22p, or slide 30p. With switch 40p, Dual 45p Dual switch 55p 1.5m Edgetype 10 for 40p.

## Skeleton Presets

Slider, horizontal or vertical standard 5p or submin 4p

## THERMISTORS and V.D.R.'s

CZ12/6/11/14. KR22. KT150. VA1005/6/8/10/10/1033/4/7/8/9 1040/1053/5 /1066/7/1074/6/7 / 1082/6/1091/6/7/8 / 1100/3/8/8602. Rod with spot blue/fawn/green. E299DDP120/218/224/338/340/350/352/YF020 E220ZZ/02 KR150 E23 glass bead YG150-S534 bead KB13 E299 DHP230, 116-121 401 (TH7, VA1104, OD10) R53 Glass bead KR100C All 7p each

RS 100-0-100 micro amp null indicator Approx. 2" x 1 1/2" x 1 1/2" £1.85

**INDICATORS**  
Bulgin D676 red, takes M.E.S. bulb 38p  
12 volt, or Mains neon, red pushfit 23p  
R.S.-Scale Print, pressure transfer sheet 12p

**CAPACITORS:** up to 500v: Ceramic up to .01 2p, to .1 5p, to .68 8p. Silvermica up to 5000PF 5p, to .01 21p. Poly. etc up to .1 2p, to .2 3p, to .47 5p, to .66 7p. .047/630V 11p. .1, .22/900v 15p. .3/600v 4p. .97/160v 7 1/2p. 1mFd up to 250v 10p. 2.2mFd up to 100v 14p. 4/16v 25p. 6.8/63, 25/50 19p. 8/20v 40p. CAN 1/350 12p. 8/660 vac £2. 3/660 vac £1.75. 5/150 70p.

Pulse Tube: 8-12kv, 10, 47, 56, 82, 100, 120; 320pF 2p each. Hundreds of others in Catalogue

**SONNENSCHNEIN/POWERSONIC DRI-FIT RECHARGEABLE SEALED GEL (Lead Antimony) BATTERY, 6 Volt 6 amp. hr. (4 1/2" x 2" x 3") £4.25**  
Ex-equipment, little used.

## CONNECTOR STRAP

Belling Lee L1469, 4 way polythene. 9p each

1 1/2 glass fuses 250 m/a or 3 amp (box of 12) 20p  
Bulgin 5mm Jack plug and switched socket (pair) 40p

Reed Switch 28mm body length 5p  
PP9 Battery Leads 8p

Aluminium circuit tape, 1/2 x 36 yards—self adhesive. For window alarms, circuits, etc. 95p

## TV MAINS DROPPERS

5 assorted multiple units for 45p

100pF air-spaced tuning capacitor £1.30  
5 1/2" x 2 1/2" Speaker, ex-equipment 3 ohm 65p

2 Amp Suppression Choke 10p  
3 x 2 1/2" x 1 1/2" } PAXOLINE 5 for 35p  
4 1/2" x 1 1/2" x 1 1/2" } 10 for 15p

Nylon clip on MES bulb holder 4p  
VALVE RETAINER CLIP, adjustable 5 for 15p

Sub-miniature Transistor Transformer 35p  
Valve type output transformer 90p

**POT CORES with adjuster**  
LA2508-LA2519 43p per pair

16 Watt Power Amp. Module  
35v 1A power required, giving 16 watt  
RMS into 8 Ω £3.45

**REGULATED TAPE MOTOR**  
Grundig 6V approx., 3" x 1 1/2", inc. shock absorbing carrier. or Jap 9V. 1 1/2" diam. £1.05

20mm fuse holder — chassis 4p, panel 17p.

Fane 8 ohm 3" sq. heavy duty communications speaker £1.60

RS neg. volt regulator 103, 306-099 (equiv MPC900) 10A, 100 watt 4-30 volt. Adjustable sort circuit protection. Sacrifice at £2.00

Digital count unit. Counts in steps of 1, 2, 5 or 10 with total limit switch (2 x D.I.L. BCD), reed relay remote output. Mains power supply, relay and delay unit. UNUSED. £5.60

Displays on 2 Minitron. 7 segments sold separately.

**AUDIO LEADS**  
3 pin d/m to open end. 1 yd. £1.10  
5 pin d/m to 2-phono. 45p  
3 pin jack plug to lag ends. 4ft. £1.30

**ACOS DUST JOCKEY**  
Automatic record cleaner £1.30

**Crouzer** 30-minute timer-programmer. multi-variable contacts £7.80

**RELAY 6 amp changeover. Mains coil**  
200μA F.S.D. level Meter 1 1/2" x 1 1/2" £3.25

**McMurdo 4 or 8 way plug and socket ex-equipment** 50p

**"Makaswitch"** 1p 10-way wafer 5p.  
Mixed pole/way 25 for £1.  
Wood cased 8-12V buzzer £2.60

**DEAC** rechargeable NICAD 450K. Capacity 6V 450 m.a.h. at 10 hour rate. Ex-new equipment £3.75  
2000 DK, 6V 2A at 10 hour rate. New £9.75.

**2.5A r.f. thermo-couple and meter** 2 1/2" square £3.86





# GREENWELD

443G Millbrook Road Southampton SO1 0HX

All prices include VAT at 15% — Just add 40p post

## BUY A COMPLETE RANGE OF COMPONENTS AND THESE PACKS WILL HELP YOU

\*SAVE ON TIME — No delays in waiting for parts to come or shops to open!

\*SAVE ON MONEY — Bulk buying means lowest prices — just compare with others!

\*HAVE THE RIGHT PART — No guesswork or substitution necessary!

All packs contain Full Spec. Brand New, Marked Devices — Sent by return of post. V.A.T. Inclusive Prices.

K001 50V ceramic plate capacitors, 5%, 10 of each value 22pF to 1000pF, Total 210. £3.69.

K002 Extended range, 22pF to 0.1uF. £3.30 values. £5.53

K003 Polyester capacitors, 10 each of these values: 0.01, 0.015, 0.022, 0.033, 0.047, 0.068, 0.1, 0.15, 0.22, 0.33, 0.47uF, 110 altogether for £5.07

K004 Mylar capacitors, min. 100V type 10 each all values from 1000pF to 10,000pF. Total 130 for £4.05

K005 Polystyrene capacitors, 10 each value from 10pF to 10,000pF, E12 series 5% 150V, Total 370 for £12.67

K006 Tantalum bead capacitors, 10 each of the following: 0.1, 0.15, 0.22, 0.33, 0.47, 0.68, 1, 2.2, 3.3, 4.7, 6.8, all 35V; 10/25, 15/16, 22/16, 33/10, 47/6, 100/3. Total 170 for £14.56

K007 Electrolytic capacitors 25V working, small physical size, 10 each of these popular values: 1, 2.2, 4.7, 10, 22, 47, 100uF. Total 70 for £3.59

K008 Extended range, as above, also including 220, 470 and 1000uF. Total 100 for £6.05

K021 Miniature carbon film 5% resistors, CR25 or similar, 10 of each value from 10R to 1M, E12 series. Total 610 resistors. £6.15

K022 Extended range, total 850 resistors from 1R to 10M £8.50

K041 Zener diodes, 400mW 5% BZY88 etc. 10 of each value from 2.7V to 36V, E 24 series. Total 280 for £16.37

K042 As above but 5 of each value £9.31

## £1 BARGAIN PACKS

- K101—16 BC2398 N.P.N. Low Noise £1.00
- K102—15 BC3498 N.P.N. Low Noise £1.00
- K103—10 BC5468 N.P.N. 80 Volt £1.00
- K104—18 BC182B N.P.N. 60 Volt £1.00
- K105—50 IN4148 Silicon Diode £1.00
- K106—18 BC184L N.P.N. Low Noise £1.00
- K107—18 BC213L P.N.P. General Purpose £1.00
- K108—8 2N5060 30N .8A SCR £1.00
- K109—15 BC114 N.P.N. Low Noise £1.00
- K114—15 XK6116 (BF241) N.P.N. 200 MHz £1.00
- K115—18 SP1218 (2N3702) P.N.P. Gen. Purpose £1.00
- K117—10 BF450 P.N.P. T.V. IF Amp. £1.00
- K118—16 ME4101 N.P.N. 60V Low Noise £1.00
- K124—50 .02uF Disc Ceramics £1.00
- K125—200 1k 5% 1/4W. CF Resistors £1.00

## VU METERS

Voo2 Twin type, 2 meters 40x40mm and driver board, supplied with circuit and connexion data. £3.50

Voo3 New type, just in. Twin type moulded in one piece, 80x40mm (No driver board but suitable circuit supplied) £2.50

## INVERTER

Prepare for the Power Cuts! Ready built inverter, 24V DC 290x53x37mm in, will power 6x8W fluorescent tubes. Circuit supplied. Only £2.90

## THE NEW 1980 GREENWELD CATALOGUE

### FEATURES INCLUDE:

- 60p Discount Vouchers
- Quantity prices for bulk buyers
- Bargain List Supplement
- Reply Paid Envelope
- Priority Order Form
- VAT inclusive prices

PRICE 40p + 20p POST

### VERO OFFCUTS

Packs of 100 sq ins of good size pieces about 4 x 3" in the following types:

- K541 0.1" copper clad.....£1.60
- K544 0.1" plain.....£1.60

Also pieces 2½x1" — 10/£1.20 100/£9 17x3½"x0.1" sheets — 10/£16.80

Large range of Standard Veroboard and boxes/cases in stock. Details in catalogue, 45p

SCOOP! Verobox type 2522, unused but has 3 ½" holes in one end and 1 ½" hole the other, so instead of £3.96, we are selling these at £1.85

### COMPONENT TRAY

Attractive yellow tray 285 x 165 x 42 mm with clear hinged lid and moveable compartments. Up to 15 can be made from dividers supplied. As an added bonus, a selection of new surplus components are included, all for the special low price of £3.95.

### SCR PANEL & REED PANEL

Z525 contains 11 800mA 60V 2N5061 SCR's, 11 6V8 zeners, 11 1N4004 diodes + R's, C's etc. Only £1.00. Z527 2 x 6V reed relays, 6 x 2S030 or 2S230 6 x 400V reats, + R's. Only 50p.

### BUZZERS, MOTORS & RELAYS

Z401 Powerful 6V DC buzzer all metal construction. 50mm dia x 20mm 70p

Z402 Miniature type 6, 9 or 12V buzzer, only 22 x 15 x 16mm. Very neat 53p

Z450 Miniature 6V DC motor, high quality type 32mm dia x 25mm high, with 12mm spindle. Only £1

W890 DIL reed relay — SPCO 2.4V — 10V 200R coil. Only £2.20

W892 Heavy duty 12V relay, ideal for car use — single 15A make contact. Coil 25R 85p

### CLOCK CASE BARGAIN

Z472 Oval format, overall size 130x-68x87mm deep, with built in stand. Rear panel drilled to accept 4 switches and alarm 60p

### 74 SERIES PACK

Selection of boards containing many different 74 series IC's 20 for £1; 50 for £2.20; 100 for £4.

### PC ETCHING KIT MK III

Now contains 200 sq. ins. copper clad board, 1lb Ferric Chloride, DALO etch-resist pan, abrasive cleaner, two miniature drill bits, etching dish and instructions £4.85

### 1A 400V RECTIFIERS

Plastic, like 1N4004, type 388F these diodes have preformed leads for horizontal mntg (15mm FC). Supersaver price — 100 for £2.30; 500/£10 1000/£18.

### POWER DARLINGTON PAIR

Plastic power (TOP66 case) transistors type 8D695A/8D696A. Just look at the spec! 70W 8A 45V — Hfe 750 at 4AII Special low price — £1.20 per pair.

### 1,000 RESISTORS £2.50!!

New stock just arrived — Carbon Film 2% and 5%, ¼W and ½W, all brand new, but have pre-formed leads, ideal for PC mntg. Enormous range of popular mixed values for just £2.50/1,000, £11/5,000 £50/25,000.

# ELECTROVALUE

## CATALOGUE

# 10

## Had yours yet?

Our computer has already selected thousands of our customers to whom our new catalogue has automatically been sent. If you would like a copy too, simply send us your name and address. It's

# FREE

(You don't even have to pay return postage)

## IT'S A GOOD DEAL BETTER FROM ELECTROVALUE

- We give discounts on C.W.O. orders, except for a few items market Net or N in our price lists.
  - 5% on orders, list value £10 or more
  - 10% on orders list value £25 or more.
 Not applicable on Access or Barclaycard purchase orders.
- We stabilise prices. by keeping to our printed price lists which appear but three or four times a year.
- We guarantee all products brand new, clean and maker's spec. No seconds, no surplus.
- Appointed distributors for SIEMENS, VERO, ISKRA, NASCOM and many others.

### OUR NEW CATALOGUE No 10

Over 120 pages. Thousands of items. Improved classification for easier selection. Valuable working information. Illustrations. Separate quick-ref price list.

# ELECTROVALUE LTD

### HEAD OFFICE (Mail Orders)

28(A) St. Judes Road, Englefield Green, Egham, Surrey TW20 0HB. Phone: 33603 (London prefix 87. STD 0784) Telex 264475.

### NORTHERN BRANCH (Personal Shoppers Only)

680 Burnage Lane, Burnage, Manchester M19 1NA Phone: (061) 432 4945.



ALL PRICES INCLUDE V.A.T. AND P. & P.

AXIAL CAPACITORS

1/25v	4p	150/25v	6p
2.2/63v	4p	160/25v	6p
3.3/50	4p	220/16v	8p
4.7/40v	4p	220/25v	8p
10/25v	4p	220/63v	9p
15/16v	5p	330/10v	9p
22/10v	5p	330/25v	9p
22/18v	5p	330/63v	12p
22/25v	5p	470/6.3v	9p
33/35v	5p	470/16v	12p
33/50v	5p	470/40v	15p
47/25v	5p	680/6.3v	12p
47/16v	5p	1000/6.3v	15p
47/50v	6p	1000/16v	20p
100/10v	5p	1500/25v	20p
100/16v	5p	2200/10v	20p
100/63v	8p	3300/16v	25p

RADIAL CAPACITORS

.47/50v	4p	220/50v	9p
1/50v	4p	220/63v	9p
2.2/25v	4p	330/10v	8p
10/40v	4p	330/25v	8p
10/50v	5p	330/50v	9p
15/16v	5p	330/63v	9p
22/25v	5p	470/6.3v	8p
22/50v	6p	470/16v	9p
33/63v	6p	470/25v	10p
47/16v	6p	1000/16v	20p
47/35v	6p	1000/25v	21p
100/35v	6p	2200/10v	23p
220/16v	8p	2200/10v	23p
220/40v	8p	3300/6.3v	24p

C280 POLYESTER CAPACITORS

.01uF	4p	.15uF	6p
.015uF	4p	.22uF	6p
.022uF	4p	.33uF	8p
.033uF	4p	.47uF	8p
.047uF	4p	.68uF	12p
.068uF	5p	.68 F 630v	10p
.1uF	5p	1.0uF	15p

AXIAL POLYESTER

.001uF	400v...3p	.047uF	160v...4p
.0015uF	400v...3p	.1uF	160v...5p
.0022uF	160v...3p	.1uF	400v...6p
.0022uF	400v...3p	.15uF	160v...6l
.0027uF	400v...3p	.18uF	160v...6p
.0068uF	400v...3p	.22uF	160v...6p
.01uF	160v...4p	.22uF	400v...6p
.022uF	160v...4p	.47uF	400v...8p
.033uF	400v...4p	1uF	160v...15p
.039uF	400v...4p		

CERAMIC DISC

.047 24v 9mm dia	3p
.1uF 30v 13mm dia	5p

CAN CAPACITORS

1250/50v	50p	10,000/10v	60p
2500/35v	70p	15,000/10v	60p

TANTALUM BEAD

.22/35v	8p	10/16v	11p
.33/35v	8p	15/16v	14p
.47/35v	8p	22/6.3v	14p
6.8/35v	11p		

HIGH VOLTAGE CAPS

Polystyrene	.1uF	10% 1000v	8p
Paper .1uF		10% 1000v	10p

DISPLAYS

TLR302 .3 inch Common Cathode	70p
TLR308 .6 inch Common Anode	£1.10
DL500 .5 inch Common Cathode	75p
FND507 .5 inch Common Anode	£1.20

DIODES

IN914	3p	IN4006	6p
IN4001	4p	IN4150	3p
IN4003	5p	IN4148	2p
IN4004	5p	DA91	4p
IN4005	6p	DA200	6p

LINEAR I.C.'s

LM380	50p	TBA820	70p
LM741	19p	TCA270SQ	55p
NE555	22p	SN70613N	£1.20
CA1310Q	£1.20	SN76023N	£1.20
CA3089Q	75p	SN76033N	£1.20
TAA350	£1.00	SN76110N	75p
TBA120A	50p	SN76131N	£1.30
TBA120S	70p	SN76660N	75p
TBA800	70p	711	40p

SUB-MIN PRESETS

Horizontal:  
100Ω, 220Ω, 470Ω, 1k, 1k5,  
2k2, 4k7, 10k, 47k, 100k.  
Vertical:  
470Ω, 2k2, 4k7, 47k.  
All price 5p each

SWITCHES

Push to make switches 16p  
Sub-min DPDT Slide switches 14p  
Standard DPDT Slide switches 12p  
Standard DPDT Toggle switches 49p  
Rotary switches 1p 12w, 2p 6w,  
3p 4w, 4p 3w All 41p each

VARIOUS ITEMS

PP3 battery clips 6p  
PP9 battery clips 14p  
Din Plugs 5 pin 180° 10p  
Din Sockets 5 pin 180°  
Standard metal type 10p  
Green Phono Plugs 6p  
Latch switches 2p 2w 10p  
20mm chassis mounting fuseholders 6p

SPECIAL OFFER

(While stocks last)

100	IN4001	£3.00
100	IN4003	£3.50
100	IN4005	£4.00
100	IN4006	£4.00
100	BC107	£7.50
100	BC109	£7.50
100	BC183L	£5.50
25	High Quality CA741 8 pin (metal can)	d.i.l. £3.25

TTL

7400	10p	7474	23p
7401	12p	7475	24p
7402	12p	7476	19p
7404	12p	7485	50p
7405	12p	7486	21p
7406	25p	7489	£1.25
7408	14p	7490	32p
7409	14p	7491	30p
7410	10p	7492	30p
7411	15p	7493	25p
7412	16p	7494	43p
7414	42p	7495	37p
7416	22p	74107	20p
7420	12p	74121	26p
7421	20p	74122	34p
7427	20p	74123	42p
7430	13p	74132	48p
7432	17p	74141	56p
7437	18p	74151	38p
7438	19p	74153	38p
7440	12p	74154	60p
7441	50p	74160	45p
7442	38p	74164	60p
7446	51p	74174	55p
7447	43p	74175	55p
7450	12p	74192	48p
7451	12p	74193	48p
7470	26p	74194	43p
7472	22p	74196	48p

CMOS

4000	15p	4027	48p
4001	18p	4028	78p
4002	15p	4030	48p
4006	91p	4035	93p
4007	15p	4040	80p
4008	78p	4041	80p
4009	41p	4042	76p
4010	36p	4043	76p
4011	19p	4044	78p
4012	15p	4046	£1.10
4013	42p	4049	42p
4014	73p	4050	42p
4015	70p	4052	65p
4016	40p	4053	65p
4017	76p	4066	48p
4018	78p	4068	15p
4019	43p	4069	15p
4020	80p	4070	22p
4021	80p	4071	20p
4022	85p	4072	20p
4024	64p	4078	20p
4025	15p		

TRANSISTORS

AD161/		BD131	30p
162 MP	75p	BD183	90p
DC36	47p	BF185	19p
BC107	9p	BF194	12p
BC107B	10p	BF195	12p
BC108	9p	BF198	12p
BC108A	10p	BF200	25p
BC109	9p	BF240	8p
BC142	21p	BF241	7p
BC147	7p	BF244	14p
BC148	7p	BF245	14p
BC149C	8p	BF255	10p
BC149S	9p	BF336	16p
BC153	8p	BFX88	28p
BC154	8p	BFY50	15p
BC171B	10p	BSX21	10p
BC172B	10p	BU208	90p
BC182L	9p	BF256	15p
BC183A	10p	TIP29	38p
BC183L	8p	TIP30	38p
BC207B	11p	TIP31A	45p
BC212L	10p	TIP32A	45p
BC213LB	10p	TIP32B	31p
BC308	10p	TIP41A	65p
BC338	10p	TIP42A	65p
BC455	7p	2N2905	20p
BC456	9p	2N2906	16p
BC547	11p	2N2907	18p
BC548	9p	2N3055	45p
BC549	9p	2N3702	9p
BCV70	11p	2N3703	9p
BCV72	12p	2N3704	9p
BD116	45p		

SAME DAY SERVICE

QUALITY COMPONENTS

Write or telephone for free pamphlet

HARRISON BROS. P.O. Box 55, Westcliff-on-Sea  
Essex SS0 7LQ

Telephone: Southend-on-Sea (0702) 32338

TRADE ENQUIRIES WELCOME

# APEL POWER SUPPLIES

STABILIZED POWER SUPPLIES WITH ELECTRONIC SHORT CIRCUIT PROTECTION

AL.212 P



£14.75

INPUT VOLTAGE	220 V ac $\pm$ 10% 50-60 Hz
OUTPUT VOLTAGE RANGE	12.6 V dc
OUTPUT CURRENT MAX	2.5 Amp
LOAD REGULATION	<0.3% 0-2.2 Amp
RIPPLE	<5mV 2.2 Amp
DIMENSIONS (mm)	W140 x H90 x D140
WEIGHT	1.490 Kg.

AL.315 P

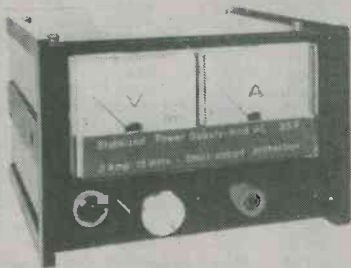

£29.50

INPUT VOLTAGE	220 V ac $\pm$ 10% 50-60 Hz
OUTPUT VOLTAGE RANGE	1.7-15 V. dc
LOAD REGULATION	<0.2% 0-2.8 Amp
DIMENSIONS (mm)	W140 x H90 x D155.
RIPPLE	3mV 2.8 Amp
WEIGHT	2.330 Kg.

AL.330 P



£46.50

INPUT VOLTAGE	220 V ac $\pm$ 10% 50-60 Hz
OUTPUT VOLTAGE RANGE	3.4-30 V. dc
OUTPUT CURRENT RANGE MAX	3 Amp
LOAD REGULATION	< 5% 0-2.8 Amp
RIPPLE	10mV 2.8 Amp
DIMENSIONS (mm)	W270 x H90 x D155
WEIGHT	4.250 Kg.

Distributed in the UK.  
and Ireland by:

## STOCKISTS

Alpha Sound Service,  
50 Stuart Road, Waterloo, Liverpool L22 4QT,  
England.

Anson Electronics,  
1133 Hessle High Road, Hull, England.

Amateur Radio Shop,  
13 Chapel Hill, Huddersfield, HD1 3ED,  
England.

Brent Electronics,  
Seaview Street, Cleethorpes,  
Lincolnshire, England.

J. Birkett,  
26 The Strait, Lincoln, England.

Bradford Consultants Limited,  
25 Regent Parade, Harrogate,  
Yorkshire, England.

F. Brown & Co. Ltd.,  
44/46 George IV Bridge Street,  
Edinburgh, Scotland.

N. R. Bardwell Limited,  
Sellers Street, Sheffield, England.

Casey Brothers,  
235 Boundary Road,  
"Saint Helens,"  
Lancashire, England.

Electronic Services Limited,  
33 City Arcade, Coventry CU11 HX, England.

A. Fanthorpe Limited,  
6 Hepworth Arcade, Silver Street,  
Hull, England.

G. W. M. Radio,  
Portland Road, Worthing, Sussex.

Leeds Amateur Radio,  
27 Cookridge Street,  
Leeds LS2 3AG, England.

Target Electric Limited  
16 Cherry Lane, Bristol, England.

New Cross Radio,  
6 Oldham Road, Manchester,  
England.

Progressive Radio,  
93 Dale Street, Liverpool L2 2JD,  
England.

R. E. Pitt Electrical Services Limited,  
60/64 Bath Buildings, Mont Pelier,  
Bristol, England.

Peats Electronics,  
Parnell Street, Dublin.

R. F. Potts,  
68 Bobbington Lane, Derby, England.

Brian A. Pearson Limited,  
66 Moncur Street, Glasgow, Scotland.

R M E Supplies Limited,  
143 Stockwell Street, Glasgow, Scotland.

Stephan James Limited,  
Warrington Road, Leigh, Lancashire.

Stewarts Radio,  
4 Chance Street, Blackpool, England.

The Radio Shop,  
16 Cherry Lane, Bristol BS 3NG,  
England.

Q. C. Trading,  
1 St. Michaels Terrace, Woodgreen M22 4FT,  
England.

AL.1 P5



£78.00

INPUT VOLTAGE	220 $\pm$ 10% 50 Hz
OUTPUT VOLTAGE RANGE	1 $\pm$ 15 V. dc
OUTPUT CURRENT MAX	5 Amp
LOAD REGULATION	< 0.1% 0.45 Amp
RIPPLE	< 2mV 4.5 Amp
DIMENSIONS (mm)	W210 x H155 x D250
WEIGHT	5.100 Kg.

AL.212 PS



£18.00

INPUT VOLTAGE	220 V ac $\pm$ 10% 50-60Hz
OUTPUT VOLTAGE RANGE	12.6 V dc
OUTPUT CURRENT MAX	2.5 Amp
LOAD REGULATION	<0.3% 0-2.2 Amp
RIPPLE	<5mV 2.2 Amp
DIMENSIONS (mm)	W140 x H90 x D140
WEIGHT	1.490 Kg.
AMPEROMETER	

AL.315 P2

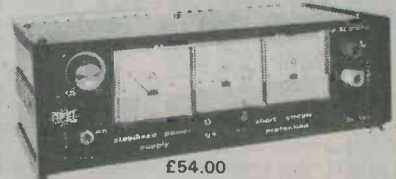

£54.00

INPUT VOLTAGE	220 V ac $\pm$ 10% 50-60 Hz
OUTPUT VOLTAGE RANGE	$\pm$ 1.7 $\pm$ 15 V dc
OUTPUT CURRENT RANGE MAX	3 Amp
LOAD REGULATION	< 0.2% 0-2.8 Amp
RIPPLE	< 3mV 2.8 Amp
DIMENSIONS (mm)	W270 x H90 x D155
WEIGHT	4.140 Kg.

Stan Willets Limited,  
37 High Street, West Bromwich.

M/S Waitons,  
55a Worcester Street,  
Wolverhampton WV2 4LL, England.

# PEAT'S WHOLESALE LTD.

Chapel Lane, Parnell St, Dublin 1, Ireland.

PHONE 741746-740678-722845. TELEX 31787.



# Conquer the chip.

Be it career, hobby or interest, like it or not the Silicon Chip will revolutionise every human activity over the next ten years.

Knowledge of its operation and its use is vital. Knowledge you can attain, through us, in simple, easy to understand stages.

Learn the technology of the future today in your own home.

## ELECTRONICS



Build your own oscilloscope.

Learn to draw and understand circuits.

Carry out over 40 experiments.

## DIGITAL TECHNIQUES

From watches to sophisticated instrumentation, Digital Electronics adds scope to hobby or career.



## COMPUTER TECHNOLOGY

Learn to operate and programme your own home computer.



**FREE BROCHURES** 

No previous knowledge is necessary.  
— Just clip the coupon for a brochure

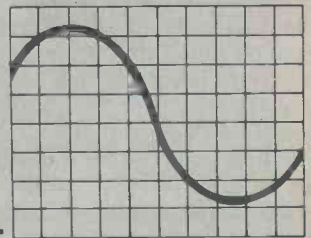

## TUTORCOURSE ELECTRONICS

Please rush me details of your ELECTRONICS COURSE

Name

Address

RER/3

Block Caps. Please

Post now, without obligation to:

**British National Radio & Electronics School.**

P.O. Box 156, Jersey, Channel Isles



SUGGESTED CIRCUIT

# ICM7555

# TOUCH BUTTONS

By G. A. French

The recently introduced ICM7555, known popularly as the "CMOS 555", is not only capable of carrying out most of the functions which could be undertaken by the very versatile bipolar 555 but it can also be used in applications which would be impossible with the 555. This is because of its exceptionally low trigger and threshold currents, given at pins 2 and 6 of the device respectively. These currents are specified as being equal, typically, to 10 picoamps at a supply voltage of 5 volts. To obtain a rough idea of the smallness of such currents, it may be noted that a current of 10 picoamps flows from a 5 volt source if a resistance of 500,000M:Ω is connected across that source.

An obvious use for a device with an exceptionally high input resistance is in a touch button circuit, wherein switching is carried out by applying a finger across two contacts. The circuit is actuated by the small current which flows

through the skin of the finger between the two contacts. This article describes a very simple touch button circuit incorporating two ICM7555's and, as a matter of interest, will discuss the steps leading to the final design.

#### INITIAL CIRCUIT

The first circuit checked out is shown in Fig. 1. Pins 2 and 3 of the i.c. are connected to a capacitor, C, and the two sets of touch button contacts as indicated. As with the bipolar 555, the output at pin 3 goes low (i.e. goes close in potential to the negative rail) if pins 2 and 6 are taken positive of two-thirds of the supply voltage. To make the output go high (i.e. close to the positive rail) pins 2 and 6 then have to be taken negative of one-third of the supply voltage. There is a high level of hysteresis here which is reminiscent of the action of a Schmitt trigger, and this is of particular advantage in the present circuit.

A voltmeter connected between pin 3 and the negative rail monitors the state of the i.c. output.

When contact set 1 is bridged by a finger, capacitor C charges and pins 2 and 6 are taken positive, causing the output at pin 3 to go low. After the finger is removed the capacitor remains charged and the output stays in the low state. The circuit will remain in this condition until C discharges to a level where the voltage at pins 2 and 6 falls below one-third of supply voltage. Since the only discharge current which flows is that through the leakage resistance of the capacitor, plus any current flowing into pins 2 and 6 and leakage current through insulated boards, etc., on which the components are mounted, the discharge of the capacitor can take a very long time.

Applying a finger to contact set 2 discharges the capacitor, takes pins 2 and 6 low and causes the output at pin 3 to go high. Again, the circuit stays in this condition until possible leakage currents or currents through pins 2 and 6 cause the capacitor to acquire a charge.

Various values of capacitance were tried in the C position. A value of 1 μF was found to be much too large, since the finger had to be applied to the appropriate contact set for about several seconds to allow the capacitor to charge or discharge. A capacitor of 0.01 μF allowed nearly instantaneous operation, and it was found that the circuit functioned adequately with capacitances of 500pF and less. A final compromise was made, with C at 2,200pF. Even with this relatively low value the circuit remained stable in its last selected state dur-

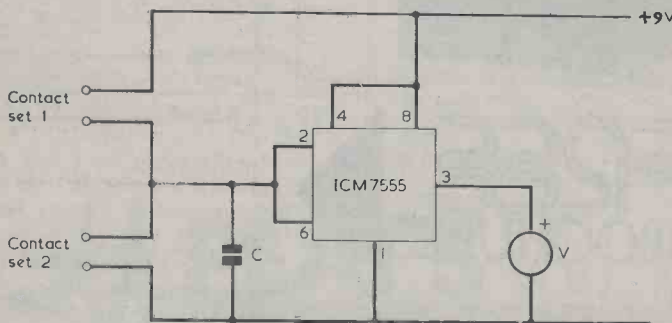

Fig. 1. Basis for a touch plate switching circuit. If contact set 1 is bridged by a finger the capacitor charges and the i.c. output goes low. Bridging contact set 2 discharges the capacitor and causes the output to go high. Even with low values of capacitance the circuit can maintain either state for a surprisingly long time



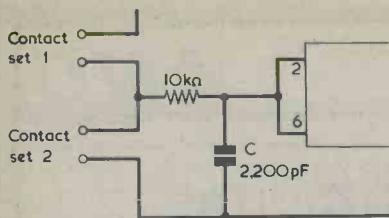

Fig. 2. Spurious triggering can be prevented by inserting a series resistor, as shown here

ing quite long periods whilst the circuit was being checked. Long-term stability could not, however, be guaranteed.

As it stands, the circuit of Fig. 1 allows pins 2 and 6 to connect directly to one of the contacts in each touch contact set. If a finger should touch this contact only, a noise voltage consisting of mains hum and other static pick-up could cause spurious triggering of the circuit. This could happen if the finger correctly bridged the two contacts and, on leaving the contacts, momentarily touched the contact connected to pins 2 and 6 on its own. The problem was alleviated by inserting a 10k $\Omega$  resistor between the contacts concerned and the capacitor, as shown in Fig. 2. The resistor and capacitor form a filter which prevents noise reaching pins 2 and 6 at sufficient amplitude to cause false operation.

### LATCHING CIRCUIT

For long-term stability some form of latching is required, and this can be achieved by adding a second ICM7555, as in Fig. 3. The second i.c. simply functions as an inverter, and its output is coupled back to the

input of the first i.c. via a 20M $\Omega$  resistor. If, now, contact set 1 is bridged by a finger, the capacitor charges and pin 3 of IC1 goes low. At the same time, pin 3 of IC2 goes high and this output maintains the capacitor in the charged condition by way of the 20M $\Omega$  resistor. The value of this resistor is too high to affect the initial charging of the capacitor via the much lower skin resistance of the finger. When contact set 2 is bridged, the capacitor is discharged and the output of IC2 goes low, maintaining the capacitor in the discharged state.

In the circuit the capacitor should be a polystyrene component. The 10k $\Omega$  resistor is a  $\frac{1}{4}$  watt 10% component, and the 20M $\Omega$  resistor consists of two 10M $\Omega$   $\frac{1}{4}$  watt 10% components connected in series. The contact sets can each be given by two nickel plated panel-head screw heads mounted close to each other on a sheet of insulating material, or by any other arrangement which allows two metal areas with shiny surfaces to be positioned close to each other. It is important that insulation resistance for all the connections to pins 2 and 6 of IC1 is of a high order.

Output loads may be switched by pin 3 of either i.c., remembering that the ICM7555 has a relatively high sink current capability but can source only low currents. Because of this, the load should be connected between the positive rail and pin 3 of the appropriate i.c. A suitable load would be the coil of an "Open Relay" with a coil resistance of 410 $\Omega$ , which is available from Maplin Electronic Supplies. This draws a current of about 20mA. With a 9 volt supply, it would be preferable to limit load current to

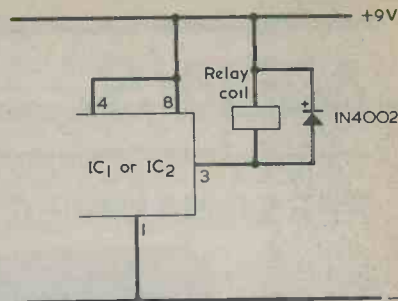

Fig. 4. Loads, such as a relay coil, may be connected between the positive rail and pin 3 of either i.c., or of both i.c.'s. The remainder of the circuit is not altered

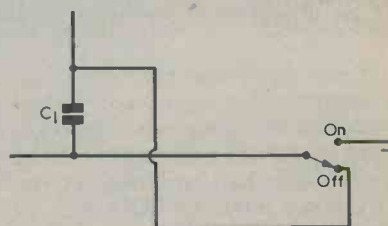

Fig. 5. In instances where it is important that C1 should always be discharged at switch-on, a pole may be added to the on-off switch which short-circuits the capacitor when the touch plate circuit, or the equipment in which it is fitted, is turned off. In the simpler example shown here, the on-off switch is in the negative supply rail and needs to be a s.p.d.t. component only

some 25mA. If desired, both of the i.c. outputs may be loaded by a relay coil, or similar. A relay coil requires a protective diode in parallel, as shown in Fig. 4.

The circuit of Fig. 3 draws a current of about 100 $\mu$  A from the 9 volt supply, plus the current consumed by any load. At switch-on the circuit will usually take up the state where pin 3 of IC1 is high, because the capacitor will tend to discharge via the 20M $\Omega$  resistor if it was charged when the circuit was previously switched off. If it is important that the circuit should reliably take up this state at switch-on, the on-off switch may be wired so that it discharges the capacitor when it is set to the "Off" position. This may require the addition of another pole to the on-off switch, or a simple arrangement such as that shown in Fig. 5 may be employed.

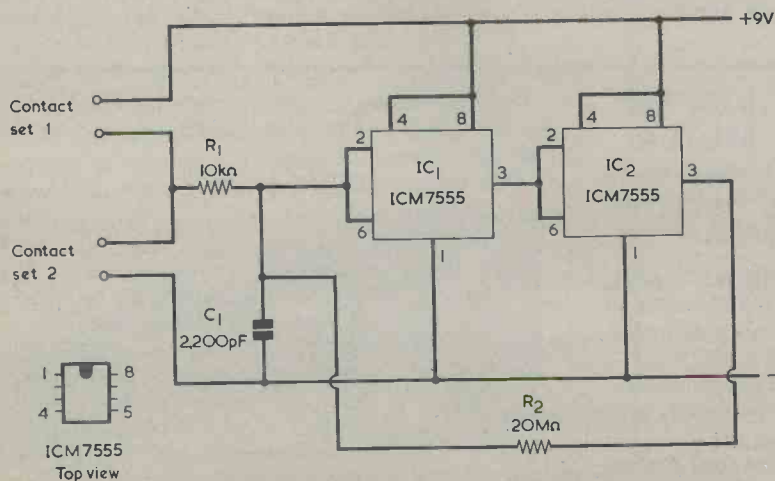
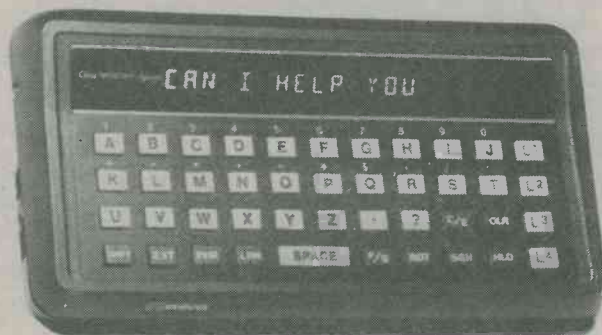

Fig. 3. The complete circuit. The second i.c. functions as an inverter and provides a latching action which ensures long term stability

## PERSONAL ELECTRONIC INFORMATION CENTRE



What is claimed to be the world's first personal electronic Information Centre and Language Laboratory is to be launched as the 'Brainbank' in the UK, by the Ring Group of Gelderd Road, Leeds.

It is a learning aid, phrase book and translator for foreign languages; a library of general knowledge, education and entertainment topics; and a personal filing system combined.

The secret of the 'Brainbank' is a series of plug-in interchangeable memory cells, these provide this hand-held, microprocessor-based

machine with an infinitely variable store of information.

Operation is via an A-Z keyboard, which includes numerals and punctuation. The unit is also programmed with 25 complete and 25 partial phrases which can be added to give full sentences, for example "May I introduce . . .", "I'd like to say . . .".

Instantaneous translation is available at the touch of a key with the foreign equivalent being displayed in bright green letters on a 16 character screen which can be rotated at different speeds to assist comprehension.

The 'Brainbank' also automatically corrects spelling errors, identifies and explains words with double meanings (eg. watch-clock, watch-see) and has a 'phonetic' cell to aid pronunciation.

As an Information Centre, the 'Brainbank' has a built-in metric conversion facility, while memory cells containing comprehensive details on Diet and Nutrition programmes, First Aid, Taxation and a Thesaurus are already complete.

Every month new cells will become available covering a wide variety of topics. Imminent titles include Cocktail Mixer Guide, a spelling Guide and various word games and puzzles. And by early 1980, blank cells, which can be programmed by users through the keyboard, will be available for recording a whole range of personal information such as telephone numbers, home budgets, addresses, travel details, supplier or product information, and literally any other form of personal or business data.

It is expected to sell at around £150 inc. V.A.T.

## ELECTRONIC DESIGN STAFF SHORTAGE

Weir Electronics Limited, of Durban Road, Bognor Regis, Sussex, who are re-organizing their activity as part of a new programme of expansion, have expressed fears that plans may be partially thwarted by the shortage of electronic design engineers.

By specialising in the design and manufacture of electronic power supply systems Weir has maintained a healthy growth rate ever since its inception in 1962, and now claims to be Britain's leading manufacturer in this field. To hold this position in today's advancing technology the Company plans to double its design and development engineering staff, and has made considerable investment in a new 6,000 sq. ft. engineering block, which is now nearing completion. Due to open in April, 1980 it is intended to be the largest R and D facility devoted to power supplies on this side of the Atlantic.

## VACUUM FLOURESCENT DISPLAY DIGITAL FREQUENCY METER

Ambit's new DFM6 is based on the functions of the DFM3 LCD frequency meter, but offering the advantages of the wide environmental capability of a VF (vacuum fluorescent) display.

As well as all the usual received frequency options, with IF offsets for all AM/FM standards, the direct count capability of this unit make it an ideal workshop instrument.

Coverage extends from 10kHz to 3.9999MHz, or to 39.999MHz for AM and shortwave applications, plus 399.99MHz in VHF.

The bright green display is clearly visible over approx. 20 feet, taking advantage of the generally improved visibility of green, with the tendency of most people to see red digits as slightly blurred — due to minor vision defects such as myopia.

The second deck visible in the photograph shows the input shaping and prescaler board, required for SW and VHF functions.

One off price £36.95 ex. V.A.T.

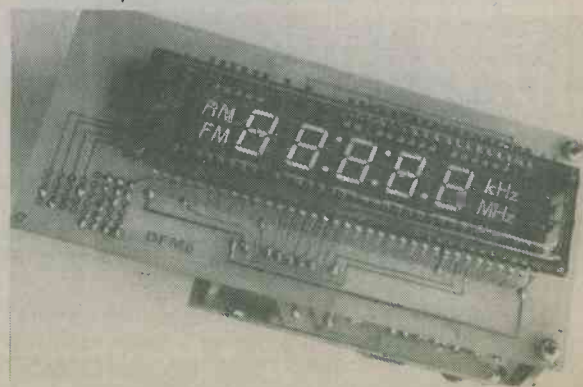



# COMMENT

## ELECTROPALATOGRAPHY

Every day reveals a new aspect of the use of electronics and the above lengthy word describes the use of electronics by scientists in the Phonetics Laboratory at Reading University.

During an average day out tongues move at least as much, and often more, than our limbs, yet remarkably little is known of how the tongue moves about the mouth. Electropalatography is the name given to the process by which the moves of the tongue can be studied, this is an important research and is being used to help people with serious speech handicaps.

Volunteers wear what looks like the upper halves of sets of dentures, plastic shields moulded to fit snugly against the upper palates, speckled with little silver dots each with a tiny wire connected to it. When we say "Cat", for example, the tongue touches the back of the mouth for the C and the front for the T. When a volunteer says "Cat" with his plastic palate shield in place, the precise points of contact of the tongue with the palate are recorded. As it touches one of the silver dots, the tongue completes a circuit, closing a switch between a tiny current too small to feel flowing through the experimenter's body and the tiny wires connected to the silver dots which act as electrodes. On a screen is a greatly enlarged replica of the palate shield, a map of the upper plate with all the electrodes marked. As the experimenter speaks, lights representing the electrodes light up as his tongue touches them.

As an example of its use — a child with a severe hearing loss can sit next to a speech therapist, each of them wearing the false plastic plate, and they each say the same words. On the screen the child can see, from the patterns formed, how near his speech is to that of the therapist sitting beside him, thus overcoming one of the problems with severe deafness — no feedback.

This is only a very brief summary of a report given in the BBC World Service.

## NEW CONVERTIBLE CIRCLIP PLIERS

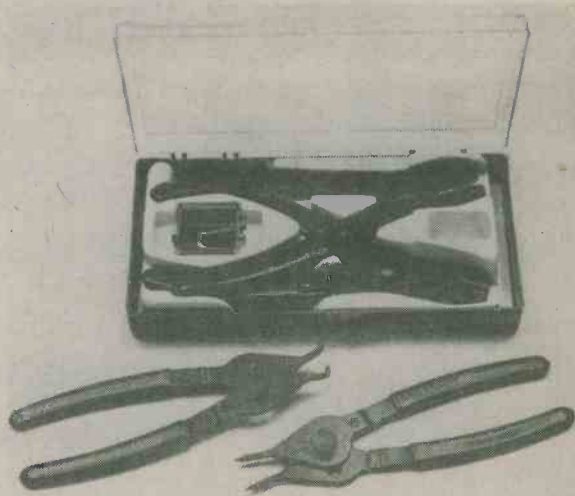

The ingenious design of Milbar circlip pliers enables use on both internal and external mounting circlips/retaining rings. Pivot screw fits in two positions for easy and quick conversion. The contoured capstan shapetips virtually eliminates slip when removing circlips. Convertible pliers are available with straight or 90 tips of 0.038" diameter.

A complete circlip plier kit is also available in a fitted case with internal and external pliers and two pairs of interchangeable colour coded tips in the following sizes: .035" dia 90, .045" dia 45, .045" dia straight, .060" dia straight.

These high quality Milbar pliers are just one of several ranges of circlip pliers stocked by Toolrange Limited and illustrated in their new colour catalogue.

The address of Toolrange is Upton Road, Reading, Berks. RG3 4JA.

## DORAM RELAUNCH

Early in 1979 the Leeds based DORAM was phased out by Electrocomponents as part of group reorganisation. The new owners are the Dutch 'DE BOER' Group who will administer the Doram business, again by mail order, from a UK based distribution centre.

Agreements have been reached between the new and original owners of the company whereby all warranties for goods purchased during Electrocomponents ownership will be honoured.

The DE BOER organisation, based in Eindhoven, centres around a shop and Mail Order business and was established over six years ago by Mr Ruud de Boer. The acquisition of DORAM will enable the Dutch group to expand in the fast growing UK home electronics market. The product range, which will include both kits and components, will be based on the current Dutch catalogue.



# STEREO MIXER UNIT

By R. A. Penfold



Unit mixes high impedance dynamic microphone and music inputs.

Modern i.c.'s give excellent performance at low cost.

Most of the cassette recorders and decks currently available are primarily intended for simple applications such as making "live" recordings with microphones, or taping records and radio programmes, etc. In either case mixing facilities are not usually needed and are not, therefore, provided. The lack of mixing facilities can make it difficult to produce a recording where speech (obtained via microphones) and music must be simultaneously recorded as in, say, a tape which is intended to accompany a film or slide show or to present an amateur theatrical production. With most recorders and decks the only way of introducing background music is to play it over loudspeakers so that the recording microphones pick up both the speech and the music. Such an approach is hardly likely to give particularly attractive results.

Much improved recordings can be made with the aid of a simple mixer such as the one featured in this article. This two channel stereo unit provides a microphone pre-amplifier (intended for high impedance dynamic microphones) in each channel and enables the microphone and music signals to be mixed at the required levels and then fed to a high level input ("Aux.", "Tuner", etc.) on the recorder or deck. Mono mixing may also be obtained by simply connecting to one channel. The very simple circuit requires only four inexpensive i.c.'s and a few discrete components, but by using modern devices a very high level of performance is obtained. The mixer is powered by two PP3 9 volt batteries, and these have a good working life as the current consumption of the circuit is only about 7mA.

## THE CIRCUIT

The circuit diagram for one channel of the mixer is shown in Fig. 1. The circuit of the other channel is identical and uses the same component number identifications. However, it should be noted that the batteries, on-off switch S1 and the bypass capacitors C1 and C2 are common to both channels. Also, VR1 and VR2 in Fig. 1 are each one section of a dual-gang potentiometer.

The circuit is based on i.c. operational amplifiers and for this reason needs dual balanced supply rails and two 9 volt batteries. The operational amplifiers are both modern low-cost Bifet types. These have Jfet input stages followed by conventional bipolar circuitry to provide the main amplification and complementary output stage. Early f.e.t. operational amplifiers used a separate chip for the input section, but Bifet devices have the f.e.t.'s and bipolar transistors fabricated on the same chip. This has enabled quite inexpensive f.e.t. input operational amplifiers to be produced.

There are several advantages offered by Bifet devices, the main one in the present application being a superior noise performance when compared with standard bipolar i.c.'s such as the 741. They also have a very high input impedance (about 1 million megohms for the LF351), a large gain-bandwidth product (typically 4MHz for the LF351), and a large full power band width (typically 100kHz for the LF351). The LF351 device specified for the mixer is available, incidentally, from Maplin Electronic Supplies.

In the circuit, IC1 is the microphone pre-amplifier and is connected in the standard inverting configuration. Here the non-inverting (+) in-

RADIO AND ELECTRONICS CONSTRUCTOR



put is biased to the central earth rail, and a 2-resistor negative feedback loop is connected between the output, inverting (-) input and the input socket. The feedback components are R2 and R1 and their values are chosen to give the required voltage gain and input impedance. The latter is roughly equal to the value of R1 while the gain is approximately equal to R2 divided by R1, or 100 times (40dB). A fairly high voltage gain is needed, as the output from a high impedance microphone is normally in the region of 2mV only.

Increased feedback, and thus reduced gain, at high frequencies is provided by C4. This feedback is not intended to attenuate the treble response of the amplifier at audio frequencies, and the -6dB point is above 20kHz. The function of C4 is to provide roll off at frequencies above the audio spectrum where stray feedback could otherwise be sufficient to cause instability.

The mixer section of the circuit appears between the output of IC1 and the input of IC2, which is connected in the same inverting amplifier mode as

## COMPONENTS

### Resistors

(All fixed values  $\frac{1}{4}$  watt 5% unless otherwise stated)

- R1 2-off 47k $\Omega$
- R2 2-off 4.7M $\Omega$  10%
- R3 2-off 12k $\Omega$
- R4 2-off 22k $\Omega$
- R5 2-off 47k $\Omega$

VR1 10k $\Omega$  dual gang potentiometer, log  
VR2 47k $\Omega$  dual gang potentiometer, linear

### Capacitors

- C1 100 $\mu$ F electrolytic, 10 V. Wkg.
- C2 100 $\mu$ F electrolytic, 10 V. Wkg.
- C3 2-off 0.47 $\mu$ F type C280
- C4 2-off 6.8pF ceramic
- C5 2-off 4.7 $\mu$ F electrolytic, 10 V. Wkg. (see text)
- C6 2-off 2.2 $\mu$ F electrolytic, 10 V. Wkg. (see text)
- C7 2-off 1 $\mu$ F electrolytic, 10 V. Wkg. (see text)
- C8 2-off 4.7 $\mu$ F electrolytic, 10 V. Wkg. (see text)

### Semiconductors

- IC1 2-off LF351
- IC2 2-off LF351

### Switch

S1 d.p.s.t. toggle

### Sockets

- SK1 2-off 3.5mm. jack socket
- SK2 2-off 3.5mm. jack socket
- SK3 2-off 3.5mm. jack socket

### Batteries

- BY1 9-volt battery type PP3
- BY2 9-volt battery type PP3

### Miscellaneous

- Metal case type TP2 (see text)
- 2-off battery connectors
- 2-off control knobs Nuts, bolts, wire, etc.

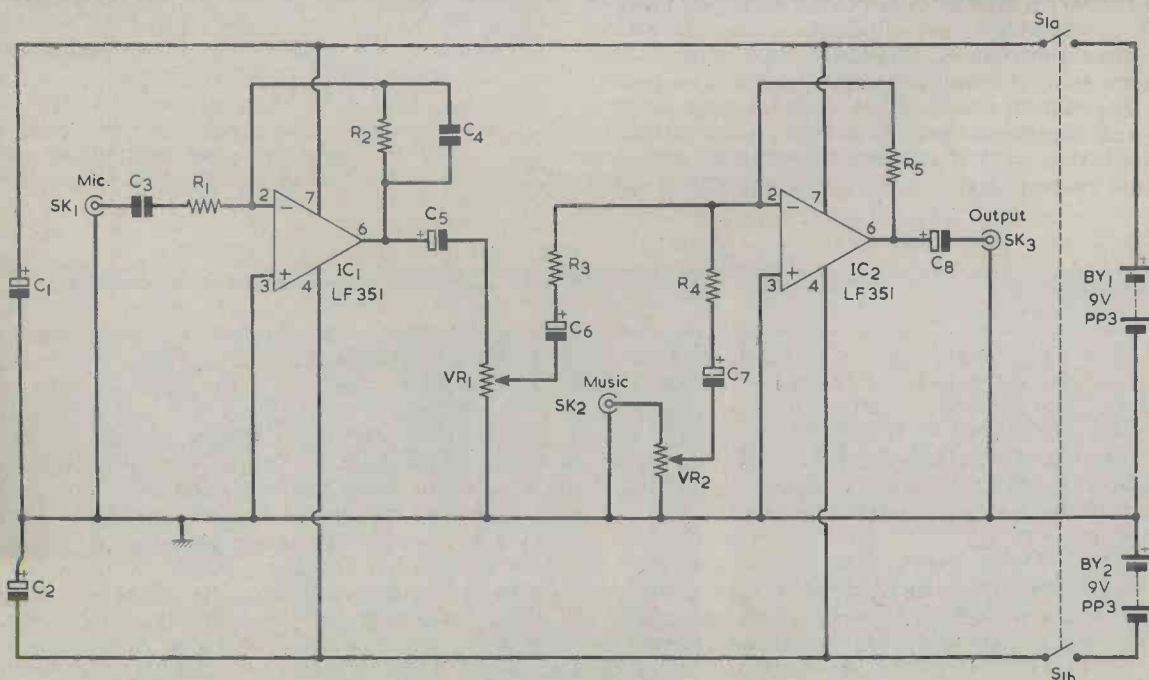
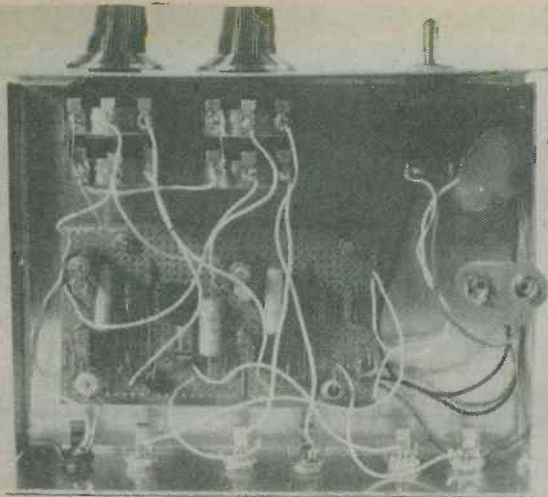

Fig. 1. The circuit of one channel of the mixer. The other channel is identical. C1, C2, S1(a)(b) and the two Batteries are common to both channels



Components inside the case are laid out in the manner shown here. The two batteries are positioned behind the on-off switch

IC1. The output of IC1 couples to potentiometer VR1, whilst the music input is applied to potentiometer VR2. The sliders of these two potentiometers couple to the inverting input via R3 and R4 respectively. The input impedance of the music input depends upon the setting of VR2 but is in general of the order of  $25k \Omega$ . The values of R5, R3 and R4 control the gain given by the IC2 to the microphone and music signals, these being roughly four times and two times respectively. The signals from the two potentiometers add at the inverting input of IC2 to give the required mixing, and the presence of R3 and R4 reduces interdependence between potentiometer settings to a negligibly low level.

In theory, a circuit of this type does not require input, interstage or output d.c. blocking capacitors because all quiescent input and output voltages should be at the central earth rail potential. In practice small offset voltages may be present and these can lead to problems including, in particular noisy potentiometer operation, and it is for this reason that d.c. blocking capacitors have

been included in the design. It is in order to use small electrolytic capacitors here despite the fact that only very low voltages may appear across them, as the circuits in which the capacitors appear are at relatively low impedance and they readily provide the required d.c. blocking and the requisite coupling capacitance. All the electrolytic capacitors are specified in the Components List as 10 volts working, but it will be found difficult to obtain capacitors of  $4.7\mu F$  or less in a working voltage as low as this. It is perfectly in order to use capacitors having a much higher working voltage, such as 63 volts.

#### HOUSING

The music unit is housed in an aluminium case having approximate dimensions of 152 by 114 by 44mm. This is a case type TP2, which can also be obtained from Maplin Electronic Supplies, and is available with a p.v.c. coated cover having a teak woodgrain or dark morocco finish. The prototype used the woodgrain version.

The layout of the mixer can be seen in the accompanying photographs. On the front panel, S1 is to the left, VR2 is slightly right of centre and VR1 is on the right. The input and output sockets, which are all 3.5mm jack sockets of open construction (i.e. not insulated), are mounted on the rear panel. Looking at the rear panel from the back, the two sockets for SK1 are to the left, the two sockets for SK2 are in the middle, and the two sockets for SK3 are to the right. The left hand socket of each pair connects into one of the mixer channels and the right hand socket of each pair connects into the other mixer channel. The first of these channels can be that to the left of the component board, as illustrated in Fig. 2, the other mixer channel being that to the right of the board.

#### CONSTRUCTION

The component board consists of a piece of 0.1in. matrix Veroboard having 20 copper strips by 37 holes. This can be cut down from a 2.5 by 3.75in. or a 3.75 by 3.75in. board (both of which have the required width of 37 holes) using a hacksaw. The two mounting holes are then drilled out 6BA or M3 clear, after which the breaks in the copper strips are made. Components and link wires are next mounted and soldered into place as shown in Fig. 2.

The component board. The i.c. at upper right of the board was inadvertently omitted when these photographs were taken, and this shows the solder-con contacts into which it fitted

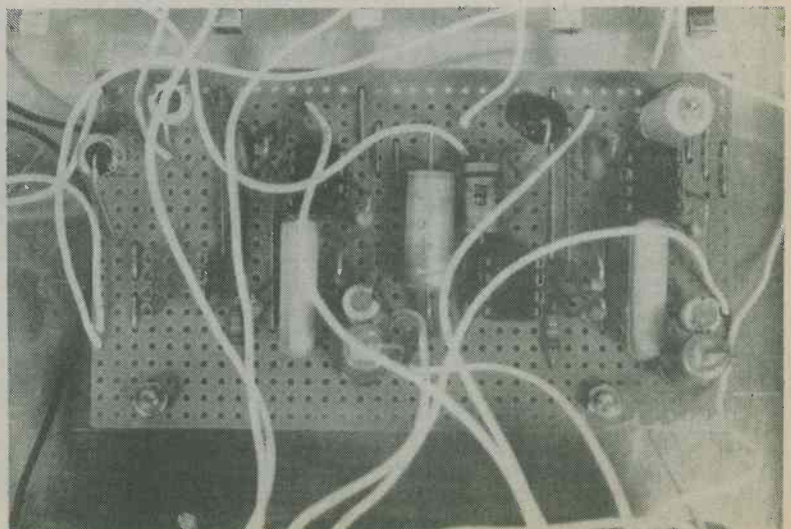



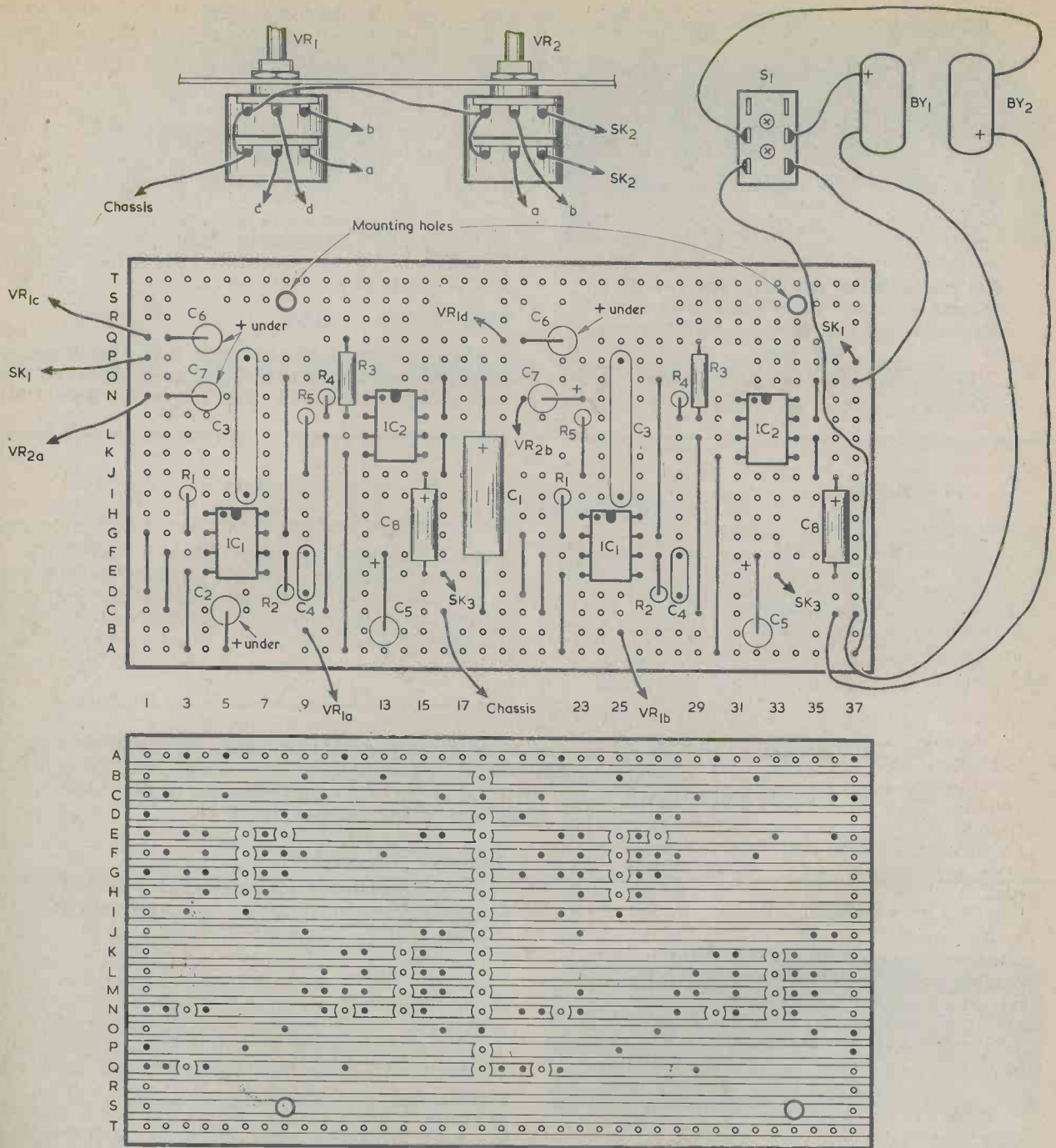
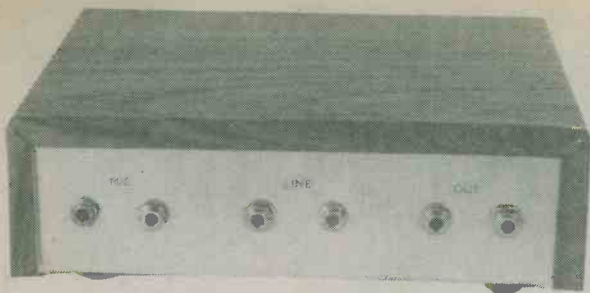

Fig. 2. Component layout and wiring on the Veroboard panel

It should be noted that the four i.c.'s have Jfet and not CMOS inputs and do not therefore require the special handling precautions applicable to CMOS devices. In the prototype the i.c.'s were fitted into soldercon sockets.

After completion, the component board may be connected to the remaining components in the circuit. These connections are also shown in Fig. 2. In this diagram, the rear sections of the two potentiometers connect to the mixer channel on the left

hand side of the board. All the connections from the board to the sockets pass to the "tip" contact tags, as illustrated in Fig. 3(a). The "chassis" wire from hole C16 of the board passes to the "sleeve" contact tag of the left hand (looking at the rear) SK2 socket, and the "chassis" wire from VR1 connects to the "sleeve" contact tag of the left hand SK1 socket. See Fig. 3 (b). The chassis connections to the "sleeve" contacts of the four remaining sockets are made automatically by way of their



The rear panel of the case. The two SK1 sockets are to the left, those for SK2 are in the centre and the sockets for SK3 are on the right

mounting bushes and nuts.

The component board is secured to the base of the housing by means of two 6BA or M3 bolts and nuts in the position shown in the photograph of the interior. Copper strip T is towards the front panel of the case. Spacing washers are required on the mounting bolts to keep the board underside clear of the metal housing base. Since the case is of all-metal construction there is no necessity to employ screened wiring inside it. There is plenty of space for the two PP3 batteries behind S1. The mixer can be finally completed by fixing a set of four cabinet feet to the underside of the case.

### THE MIXER IN USE

After a final check of the wiring, the mixer is ready for use. Input and output connections to the unit should be made with screened wire, the

'Tip' contact tag

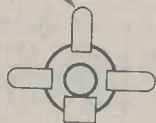

(a)

'Sleeve' contact tag

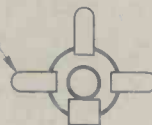

(b)

Fig. 3(a). Connections from the component board to the sockets are taken to the "tip" contact tag, as illustrated here  
 (b). The "chassis" wires from VR1 and the component board are connected to the "sleeve" contact tag of the appropriate sockets

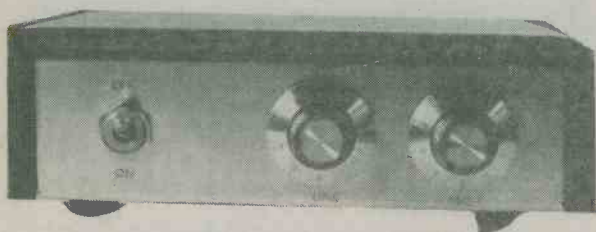

The on-off switch is to the left of the front panel, with VR1 to the right. VR2 is slightly right of centre

braiding of which is common with the "sleeve" contact of the associated 3.5mm. jack plug. If desired, an arbitrary choice can be made to designate one channel "Left" and the other channel "Right". Since both channels are identical the manner in which they are so named is of no importance.

The music input of the mixer can be fed successfully from any normal tape deck or tuner, but it cannot be fed direct from a crystal, ceramic or magnetic pick-up. A suitable pre-amplifier must be interposed, and one way of achieving this is to feed the pick-up into its amplifier in the normal way and then feed the mixer from the tape output or "Aux." output of that amplifier.

### BACK NUMBERS

For the benefit of new readers we would draw attention to our back number service.

We retain past issues for a period of two years and we can, occasionally, supply copies more than two years old. The cost is 70p inclusive of postage and packing.

Before undertaking any constructional project described in a back issue, it must be borne in mind that components readily available at the time of publication may no longer be so.



# RADIO-COUPLED MORSE OSCILLATOR

By T. Bowen

A very simple circuit for morse practice

This inexpensive circuit will be found helpful to anyone who is seeking to gain practice in morse sending. For receiving practice, the key can be operated by a fellow enthusiast or by a person having a higher degree of skill in the morse code.

The morse oscillator requires very few parts. Its 1kHz output is reproduced over the speaker of a radio tuned to medium or long waves.

## COMPONENTS

### Resistors

R1 1M $\Omega$  5%  $\frac{1}{4}$  watt  
R2 220k $\Omega$  5%  $\frac{1}{4}$  watt

### Capacitor

C1 1,000pF polystyrene

### Integrated Circuit

IC1 ICM7555

### Switch

S1 morse key

### Battery

BY1 9-volt battery

### Miscellaneous

Metal plate (see text)

## MULTIVIBRATOR

The circuit appears in the accompanying diagram. This is a standard 555-style multivibrator, but since an ICM7555 is employed current consumption from the 9 volt battery is very small. Also, R1 is given a high value to ensure that only a low current flows in the timing resistor chain. The measured consumption of the prototype was 70 $\mu$ A, and this current only flows when the morse key is pressed.

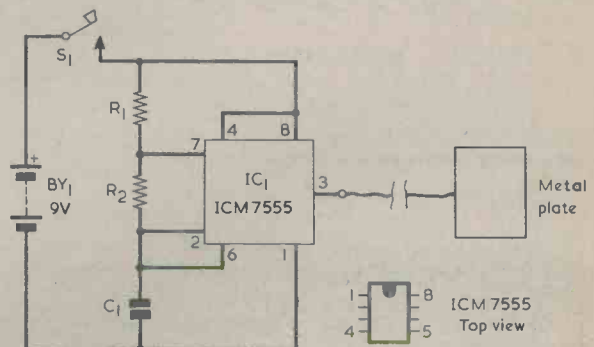

The frequency of operation is approximately 1kHz. A rectangular waveform at this frequency appears at the output, pin 3, of the i.c., and this has harmonics which enter the medium and long wave bands. The output couples via a wire, between 12 and 18 inches in length, to a flat metal plate having approximate dimensions of 4 by 4 inches. Any metal may be employed and an oddment of aluminium sheet or tinfoil would be suitable.

The plate is placed on an insulated surface, such as the top of a wooden table, and a portable radio switched to medium or long waves is placed on it. The radio is then moved relative to the plate until the 1kHz tone of the oscillator breaks through at the strongest level. The particular radio employed by the author, a Pye "Piccolo", gave best results with its back laying on the plate. The radio should be adjusted to a frequency which is reasonably free of broadcast signals, and its volume control functions as the volume control for the oscillator.

# SHORT WAVE NEWS

## FOR DX LISTENERS



By Frank A. Baldwin

Times = GMT

Frequencies = kHz

### THE FAR EAST

Last year around this time mention was made in these columns of the 'Quest for Laos' and the total lack of success in that venture. This time there is some success to report and additionally other loggings from the Far East to mention. We commence with:

#### ● LAOS

All the frequencies have been 'visited' many times but up to the time of writing there is only one Loation transmitter has been logged — and that is presumed, no identification being heard. Luang Prabang on a measured **6997** at 2318 to 2325 (when signal lost), local-style music (very similar to Chinese music), YL with songs, YL announcer. Poor signal strength surrounded by commercial QRM but unmistakable programme content. The frequency was correct and the time was right — and I have it on tape! The 'Quest for Laos' continues.

#### ● CHINA — REGIONALS

Fujian Front PLA (People's Liberation Army) on **3535** at 2131, OM in Chinese to Taiwan and other Offshore Islands, scheduled from 1700 to 2144 on this channel. Much QRM (interference) from Amateur CW (Morse) signals.

CPBS (Chinese People's Broadcasting Station) Wuhan, Hubei, on **3940** at 2235, OM in Chinese. The schedule is from 2100 to 0610 and from 0850 to 1605.

Kunming, Yunnan, (Yunnan People's Broadcasting Station) on **4760** at 2240, YL in Chinese in a relay of the Radio Peking Domestic Programme 1. The schedule is from 2150 to 0600 and from 0920 to 1605, relaying Peking 1 at 2230 and 1200 for half an hour, otherwise the local Yunnan 1 programme.

PLA Fuzhou on **4045** at 1525, OM and YL alternate in Chinese. The schedule is from 1000 to 0530, entirely in Chinese, as part of the Foreign Service 1.

CPBS Nanning, Guangxi, on **5010** at 2140, OM and YL with Chinese opera programme. This is Guangxi 2, scheduled from 2115 to 2200 and from 0950 to 1530. It has a transmission in Russian from 1300 to 1400.

CPBS Quinghai on **3950** at 2151, sign-on with choral 'East is Red' theme, YL with opening announcements followed by Chinese classical music. Based at Xining, this transmitter operates entirely in Chinese from 2150 to 0100 and from 0930 to 1525.

#### ● INDONESIA

RRI (Radio Republik Indonesia) Banda Aceh, on **4955** at 2309, OM with a talk in Indonesian (Malindo). The schedule is from 2300 to 0015 (Sundays to 0600) and from 0800 to 1600. The

frequency can, and does, vary to **4954**. The power is 10kW.

RRI Padang on a measured **4003** at 1520, local-style orchestral music, YL with songs. The schedule here is from 2230 to 0045 and from 1000 to 1600 (variable closing time). Like Banda Aceh, it relays a newscast from Medan at 1400. The power is 10kW.

RRI Palembang on a measured **4856** at 1546, OM song in Indonesian, local-style musical backing. The schedule is from 2230 to 0115 (Sundays until 0700) and from 0900 to 1600. The power is 10kW. Listed **4855**, it also relays Medan at 1400. The power is 10kW.

RRI Palembang on a measured **4856** at 1546, OM song in Indonesian, local-style musical backing. The schedule is from 2230 to 0115 (Sundays until 0700) and from 0900 to 1600. The power is 10kW. Listed **4855**, it also relays Medan at 1400.

RRI Banda Aceh on **3905** at 1551, OM with prayers from the Holy Quran, YL announcer, guitar melody (not 'Love Ambon') off at 1559. Schedule as on **4955**.

#### ● MALAYSIA

Kuala Lumpur on **4845** at 1510, YL with songs in the Tamil programme, scheduled from Mondays to Fridays 2130 to 0130 and from 0545 to 1530. Saturdays from 2130 to 0330 and from 0545 to 1530. Sundays from 2130 through to 1530. The power is 50kW.

BBC Tebrau on **3915** at 1530, OM with football commentary in English. This BBC station relays programmes in Chinese, Vietnamese, Burmese and Indonesian, the schedule being from 2230 to 2345, 1000 to 1100 and from 1130 to 1445. From 1500 to 1830 the programmes are entirely in English. The power is 100kW.

Penang on **4985** at 1554, OM with a ballad in English. The schedule is from 2230 to 0130 (Sundays until 1630) from 0530 to 0630 (Saturdays until 1630) and from 0930 to 1630, programmes being in English and vernaculars. The power is 10kW.

Kuching, Sarawak, on **4950** at 1548, YL with English pop records and announcements. The schedule is from 2200 to 0100 and from 0800 to 1600 with programmes in English and Chinese. The power is 10kW.

#### ● SRI LANKA

SLBC Colombo, on **4870** at 1540, OM with a talk in the Home Service 2 in Sinhala. This one is scheduled from 0015 to 0300 and from 1030 to 1730. The power is 10kW.

#### ● BURMA

Rangoon on **4725** at 1440, OM in vernacular (presumably Burmese) YL with local-style songs. Programming in Burmese and vernaculars, this

RADIO AND ELECTRONICS CONSTRUCTOR



one is scheduled from 1030 to 1445, the power being 50kW.

Rangoon on 5040 at 1558, YL with song, OM with identification and announcements in English, National Anthem and sign-off at 1600.

#### ● INDIA

AIR (All India Radio) Delhi, on 3905 at 1918, YL in Arabic in the Foreign Service, scheduled from 1800 to 1945. The Home Service on this channel is scheduled from 0240 to 0250 and from 1230 to 1235 with newscasts in English. The power is 100kW.

AIR Calcutta, on 4820 at 1544, YL with songs, local music. The schedule is from 0025 to 0215 and from 1230 to 1740 but sometimes signs-off as late as 1830. The power is 10kW.

#### ● MONGOLIA

Ulan Bator on 4830 at 2202, opening with National Anthem, OM with announcements in Mongolian. A late opening! The schedule is from 2200 to 2230 with the Home Service and is listed in parallel on 4850, 4995 and on 5053. This is the Home Service and was formerly operating on 4762 and 5053.

#### ● CHINA

Radio Peking on 9880 at 2008, OM & YL with a 'Chinese by Radio' programme in the English programme (confusing isn't it?) to North and West Africa, scheduled from 1930 to 2030.

Radio Peking on 9900 at 2013, Chinese music, OM with the Portuguese programme for Africa and Europe, scheduled from 2000 to 2100.

Radio Peking on 6345 at 2122, YL with songs in Chinese in the Domestic Service 2 programme, scheduled on this channel from 2100 to 2400.

Radio Peking on a measured 6493 at 2119, with physical training instructions to music in the Domestic Service 1, scheduled here from 2000 to 2300.

#### ● ECUADOR

La Voz de los Caras, Bahia de Caraqueas, on 4795 at 0318, YL with a local pop song in Spanish, OM announcements. The schedule is from 1300 to 0400 (Sundays until 0520) and the power is 3kW. The frequency of this one however varies at times from 4794 to 4796.

#### ● COLOMBIA

La Voz del Cinaruco, Arauca, on 4865 at 0335, OM with identification followed by a sudden switch-off without the National Anthem. As this one has a 24-hour schedule, a breakdown must be assumed. The power is 1kW.

Radio Cinco, Villavicencio, on 5050 at 0340, OM with identification at 0346 and again at 0400, followed by announcements in Spanish and a programme of local-style dance music. This is a move from 5040 to avoid interference from Radio Maturin, a 10kW transmitter. Radio Cinco is listed at 3kW. By the time this is published they may either (a) be back on their usual channel or (b) have moved elsewhere.

#### ● YUGOSLAVIA

Belgrade on 9620 at 1850, local-type music followed by OM with announcements in the English programme for Europe, the Middle East and Africa, scheduled from 1830 to 1900 on this channel and in parallel on 6100 and 11735.

#### ● BULGARIA

Sofia on 9700 at 1930, OM identification and the English programme for Europe, scheduled from 1930 to 2000. Also in parallel on 11720.

#### ● AUSTRIA

Vienna on 9585 at 1900, OM with identification and announcements at the start of the German programme for EDurope, West and South Africa, scheduled from 1900 to 2030 and in parallel on 6155, 15135 and on 15320.

#### ● PORTUGAL

Lisbon on 9740 at 1930, YL with identification in the Portuguese programme for Europe, scheduled from 1830 to 2030 and in parallel on 6025. The English programme is scheduled from 2030 to 2100 (not on Sundays).

#### ● ROUMANIA

Bucharest on 9690 at 1938, YL with news in the English programme for Europe, scheduled from 1930 to 2030 and in parallel on 11940.

#### ● FINLAND

Helsinki on 9770 at 1945, OM and YL with the English programme for Europe and Africa, scheduled from 1930 to 2000.

#### ● SWITZERLAND

Berne on 9535 at 1843, OM identification and announcements at the end of the English programme for Africa, Europe and South America, scheduled from 1815 to 1845.

#### ● VATICAN CITY

Vatican on 9645 at 1947, YL with the Rosary for Europe and all Africa, followed by identification and a newscast in English at 2000. Also in parallel on 9625.

#### ● SPAIN

Madrid on 9685 at 2045, OM with identification and a newscast, followed by typical Spanish music in the English programme for Europe, scheduled from 2010 to 2110.

#### ● MOROCCO

Tangier on 21735 at 1304, OM with the news in Arabic in the Radio Morocco Domestic Service in Arabic, scheduled on this channel from 1100 through to 2200.

#### ● CUBA

Havana on 9720 at 1843, OM and YL alternate with announcements in the Spanish programme for the Mediterranean Area, scheduled from 1800 to 2000.

#### ● ALBANIA

Tirana on 9500 at 2020, YL with identification in the French programme for Europe, scheduled from 2000 to 2030.

#### ● POLAND

Warsaw on 9675 at 2008, OM and YL with the English programme for Africa, scheduled from 2000 to 2030.

#### NOW HEAR THIS

Clandestine, "Radio Freedom from South Yemen", on a measured 9953 at 1827, OM with a political tirade in Arabic followed by a selection of local-style music.

Clandestine, "Voice of the Egyptian People", on 9730 at 1900, opening with a marching song in Arabic. After an anti-Sadat programme, closed at 2000 with the same marching song.

# BRITAIN'S FIRST AMATEUR SPACECRAFT TO BE LAUNCHED IN 1981

The National Aeronautics and Space Administration has formally agreed to launch Britain's first amateur spacecraft, UOSAT. It will form a secondary payload on the launch of the Solar Mesosphere Explorer mission from the Western Test Range in California, at present scheduled for 30 September 1981. The Thor-Delta launch vehicle is planned to place UOSAT in a circular polar orbit at a height of 530 km. The launch opportunity is being provided by NASA in view of the satellite's potential contribution to space science education and to the investigation of radio propagation phenomena.

UOSAT is being built at the University of Surrey, in close collaboration with the International Amateur Satellite Corporation (AMSAT), the Amateur Satellite Organisation of the UK (AMSAT-UK) and the Radio Society of Great Britain. Much support is being given by Britain's electronics, telecommunications and space industries.

The purpose of the spacecraft is primarily educational. It will carry a series of high-frequency radio beacons, enabling individual radio amateurs and science groups in schools and colleges to study the changing effects of the ionosphere on radio-wave propagation. Further experiments of interest to schools are in the planning stage and will be announced when their design details are confirmed.

An additional experiment likely to cause considerable scientific interest is a three-axis magnetometer. This should make possible a detailed study of the magnetic fields of the earth's polar regions. The instrument will be built by an amateur radio enthusiast at the Goddard Space Flight Centre, Mario Acunia, and will be based on the very successful instrument he built for the VOYAGER mission to Jupiter.

Steady progress with the project as a whole is being made as follows (work carried out at the University of Surrey unless otherwise stated):

- the overall system design has been confirmed
- the structure of the spacecraft has undergone redesign and structural analysis (British Aerospace Dynamics Group).
- a survey has been made to determine the most suitable method of stabilising the spacecraft and of keeping it the right way up.
- a low power microcomputer system has

been constructed to 'breadboard' stage (Mike Stubs, Ferranti).

— a telecommand receiver has been constructed to 'breadboard' stage and has operated continuously for three months without problems.

— a first prototype radio beacon, operating at 145MHz, has been constructed.

— a number of spare solar panels from the UK-6 project have been donated (Science Research Council).

One of the limitations in building an unmanned spacecraft is that there is no way of repairing components which go wrong during or after launch. To avoid such problems as far as possible, spacecraft are built in three stages.

**1. 'Breadboard' Stage:** each of the proposed electrical and electronic systems in the spacecraft is first constructed as a circuit on a flat board. The purpose of this is to test each circuit to check that its performance matches the original design specification. This is known as the 'breadboard' stage because in the early days of electronics, amateur enthusiasts sometimes used the family breadboard as a base on which to fasten the various components.

**2. Engineering Model:** each of the systems and experiments is then built in its final form and everything is assembled on the spacecraft chassis. The engineering model is, to all intents and purposes, a finished spacecraft but it is not normally launched. Instead it is subjected to heating, freezing, vacuum, vibration and other forms of maltreatment in order to trace any weaknesses.

**3. Flight Model:** this is a repeat of the engineering model, incorporating improvements as a result of experience gained in testing and ground operation. It also goes through extensive tests, though not to the rigorous extent suffered by the engineering model. This is the version that actually goes into orbit, though if it fails completely (as a result of the launch vehicle failing to go into orbit, for example) the engineering model can be used as a successor if an alternative launch opportunity exists.

The three phases of construction overlap considerably in time. At present the 'Breadboard' stage for UOSAT is planned by August 1980, the Engineering Model by December 1980, and the Flight Model by August 1981.

## RTTY Journal

### Subscription Manager Change

After 13 years as UK Subscription Manager, Arthur Owen, G2FUD, is handing over the subscription managing arrangements for the "RTTY Journal" to Arthur Gee, G2UK.

The "RTTY Journal" is an exclusively amateur radioteletype journal, edited and published by Dee

Crumpton, California, U.S.A. It is published ten times a year, the May and June issues and the July and August issues, being combined.

The annual subscription rate, including postage, in this country is £6.00. G2UK's address is: 21 Romany Road, Oulton Broad, Lowestoft, Suffolk, NR32 3PJ.





series  
No. 8

*really explains*  
*microprocessors*

By Ian Sinclair

# INTERRUPTS

This month we see how the program may be interrupted to allow data to be fed into the microprocessor.

In part 7 we looked at programmed inputs and outputs, in which the main program that is running the CPU decides when an input is to be read by the CPU or when the CPU is to write data out. Similarly, the program decides which in/out port is to be used for these operations.

Now this isn't always particularly convenient, for a number of reasons. One reason is that the program may result in the inputs being connected many times per second, even if there is no change in the data at the input. Another possibility is that the data at the input may be missed; it may, for example, be changing just as the program causes it to be read by the CPU. In particular, a programmed input for a keyboard is most unsatisfactory because it means that an input/output program must keep running continually in a loop, ready for an input if there is one.

The problem is solved by an interrupt process. As the name suggests, this involves interrupting the main program — the full title of the process is asynchronous input interrupt'.

## TAKING CONTROL

What does an interrupt involve? For one thing, it means that whatever device (keyboard, D-to-A converter, etc) causes the interrupting signal then takes control of the CPU for a time, so that its signals can be read by the CPU into the accumulator without waiting for a particular part of the program to come along. This is particularly useful for a device like a keyboard, where the inputs may come only once a second or so. If we made the input instruction part of the main program, we would have to loop this part of the program so that it continually repeated. It might repeat thousands of times for each key pressed, rather a waste of program time when only one of

these readings is actually needed. An interrupt, then, is a method of transferring data bits to the CPU only when there are some bits of data ready waiting. This is nearly always a more satisfactory method of putting data in from keyboards and similar sources of data signals.

It all looks very satisfactory, but we run into a lot of problems when we start to think about what happens. First of all, the device (keyboard, transducer or whatever)

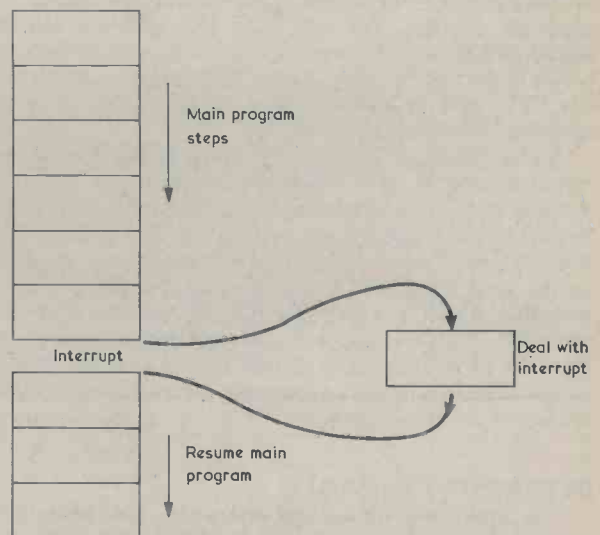
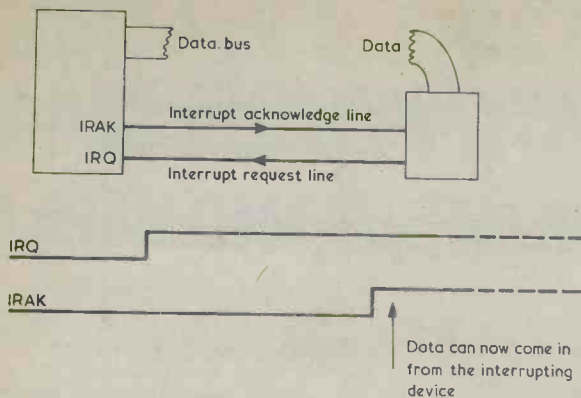

Fig. 1. An interrupt. The main sequence of the program is broken by an interrupt signal from a device outside the CPU. This interrupt signal must then be processed before the program sequence can continue



**Fig. 2. Interrupt request and acknowledge.** The interrupting device sends out an interrupt request signal, but is not connected to the data bus until an interrupt acknowledge is sent out by the CPU. In this way, the interrupt does not cause a program step to be lost

which provides the data has to make some signal to the CPU that it has data to be read by the CPU. This is done by putting a signal into an "interrupt request" pin on the CPU, so this particular problem is easily solved provided we can obtain such a signal from the device. The real problems come when we look at what the CPU is going to do. Should it "drop everything" and read data into the accumulator whenever the interrupt request signal comes in? For a number of reasons, this is impossible. The CPU may, for example, be in the middle of carrying out an instruction. If data is being fetched from memory or written out to memory, it would cause chaos if the data lines were suddenly connected to a keyboard, for example. We must have some method of allowing the CPU to finish what it is doing before it pays any attention to the signal on the interrupt request pin. This, fortunately, isn't difficult, because a signal is always available at the end of an instruction — it is the signal which increments the program counter. We can gate the interrupt request signal with this end-of-instruction pulse, and employ the result to permit the interruption. This signal is used inside the CPU, and is also available as an output on a pin labelled "interrupt acknowledge".

So far, so good. The sequence now is like this: the external source of data (keyboard to you!) sits idle until there is some data to send to the CPU. At this time, an interrupt request signal is sent out to the CPU, but the CPU doesn't permit the data from the external device to get on to the data lines until it has reached the end of the instruction which it is carrying out. At the end of the instruction, the interrupt acknowledge signal is sent out from the CPU. This signal can be used to gate the data on to the data bus lines, for example, by switching a buffer circuit or an in/out port.

### INTERRUPT DISABLE

The interrupt acknowledge signal also does something else — it disables the interrupt system so that any new interrupt request signal has no effect. Why? Because if another interrupt request is received before the CPU has finished dealing with the present one, there will be two lots of data going in, and the CPU has no way of dealing with this sort of thing. We'll look briefly later at how the problem can be dealt with.

Disabling the interrupt in this way prevents any further interruption. On the face of it, you might think that this made life a bit difficult, that only one interrupt could ever happen. That would be true if the program ran only once, because the instruction to allow an interrupt to happen (interrupt enable) is a program instruction. An operating program for a device like a keyboard, however, will have the interrupt enable instruction at the end of each piece of program, so that the interrupt system is enabled again at the end of each interrupt — more of this later.

Now we come to two really tough problems, which have to be tackled together because they are closely related. Problem number 1 is what happens to all the data which is stored in the CPU when the interrupt occurs? There will be a byte of data bits in the accumulator, for example, and the next step of the program may, for instance, add another number to this or store the accumulator number into memory. If we interrupt and load in another byte from a keyboard or whatever, the number byte which was in the accumulator is lost, so the program can never continue correctly. In the same way, the program counter will have reached a step number which normally would fetch the next step of the main program. We can't allow this to happen, because of the interrupt, so what happens to this program step number? Similarly, what happens to the numbers stored in the data register and the status register? These numbers will all be needed for the main program when it takes up again, but they may be altered or erased by the interrupt so that we need some way of keeping them tucked away ready for use again.

Problem number 2 is — just what does the CPU do when it gets a byte of data from outside? Its normal program has been interrupted, there's a byte loaded into the accumulator — what happens to that byte? The answer to both problems is that a special program has to exist somewhere in memory to deal with an interrupt. This special program is called an "interrupt service routine", and it's rather like a sub-routine. The interrupt service routine swings into action whenever an interrupt is signalled, so that the data sent into the accumulator is processed in the correct way.

This processing might be no more than transferring the data to memory, but the interrupt service routine allows us to solve the other problem as well — so allowing the data that was present before the arrival of the interrupt to be preserved. Here's how.

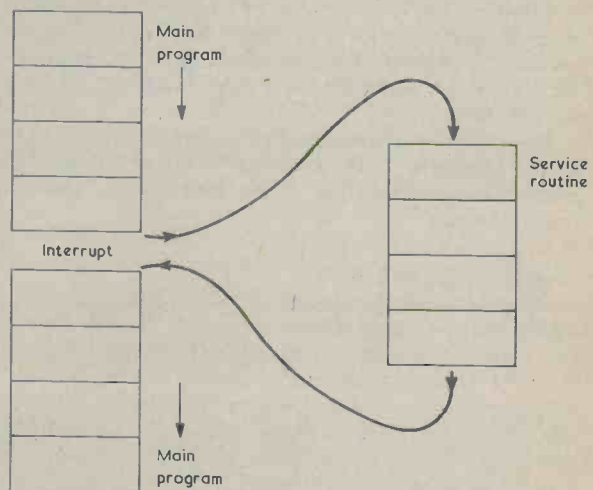

**Fig. 3. The interrupt service routine is a piece of program which is carried out for each interrupt**



## PUSH AND POP

A large number of CPUs have a small bit of memory built in — it's called the "stack". If there's no stack, there's usually some way of using a bit of RAM as a stack, and all the RAM addressing that is needed can be done by the CPU. What makes the stack so useful is that it's organised as a "first-in-last-out" type of memory — we can store data bytes in order and take them out in reverse order. The operation of putting a byte into the stack memory is called "push", and the opposite operation of recovering the byte is called "pop".

What do we make of the show so far? At the start of an interrupt service routine, the program instructions will be to push the accumulator contents on to the stack, then the program counter number, then the data counter number, the status register number and so on for each register we need to preserve. This set of instructions will then be followed by the instructions which process the data that was read in from the keyboard or other device. That attends to the needs of the interrupting data. The next part of the service routine is to pop the stack in reverse order — if the status register byte was last in, then it's first out. Finally, if there is going to be another interrupt some time, as there certainly will be from a keyboard, the instruction "interrupt enable" can be included when the normal program is resumed.

It all sounds very satisfactory, but there's still one unanswered question. When the interrupt request is received and acknowledged, where does the interrupt service program come from? Obviously, the service program is stored somewhere in memory, but how is the address of the start of this program sent in to the program counter so that the service routine can be started? Here, once again, we find a considerable difference between one CPU and another. The INS8060 (SC/MP) uses a very simple and effective scheme — the starting address for the interrupt service routine is loaded into a register called "Pointer Register 3", or "P3". This loading can be carried out early in the main program, and the instruction to enable interrupts for the first time can follow it. When an interrupt request is received and acknowledged, the bytes in P3 are exchanged with the bytes in the program counter. This puts the starting address of the service routine into the program counter, and stores the next address for the main program in P3. The service routine then carries out the push operations (not quite so easy on this CPU, because there is no built-in stack), services the interrupt, enables the next interrupt and then jumps back to the "Exchange Program counter and P3" instruction. Because of the jump back, the address which is loaded back into P3 is the *starting* address for the interrupt service routine, not the *finishing* address as it would be if this instruction came at the end of the routine. The address which is exchanged back from P3 into the program counter is the correct "next step" for the main program.

## DIFFERENT DEVICES

Other CPUs use much more elaborate systems which can enable interrupts from several different devices. These systems depend on each interrupting device putting a single-byte code into the CPU which selects a fixed starting address for the correct service routine. The programmer must then ensure that there is a suitable servicing program at each of these fixed addresses. Methods like this require another chip to generate the "start address" code byte for each interrupting device.

What about interrupts which come together or very close to each other? It's a bit outside the scope of this series, but briefly what happens is that logic is needed to ensure that the interrupts are dealt with one at a time.

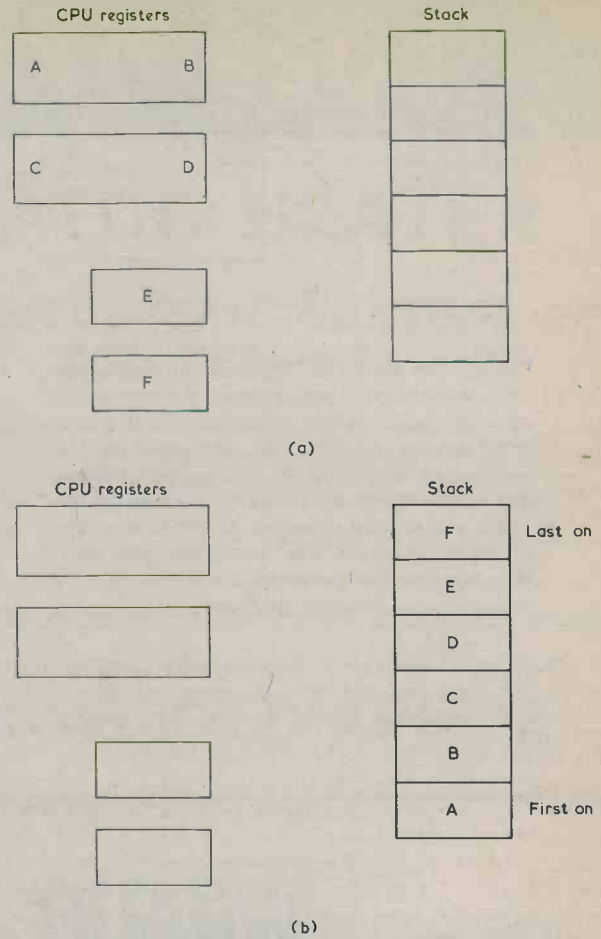

Fig. 4. The stack. The contents of the CPU registers can be "pushed" on to this set of memory registers in sequence, and "popped" off in opposite sequence. This allows the CPU to save the contents of its registers when it processes an interrupt.

(a) Before push, (b) after push

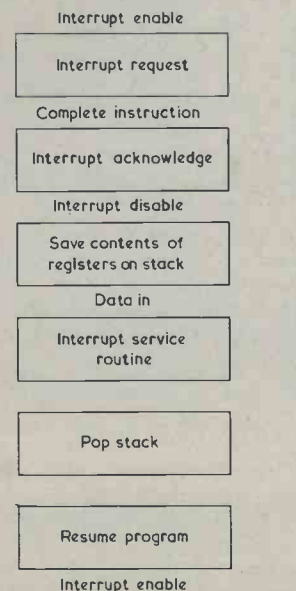

Fig. 5. The interrupt sequence

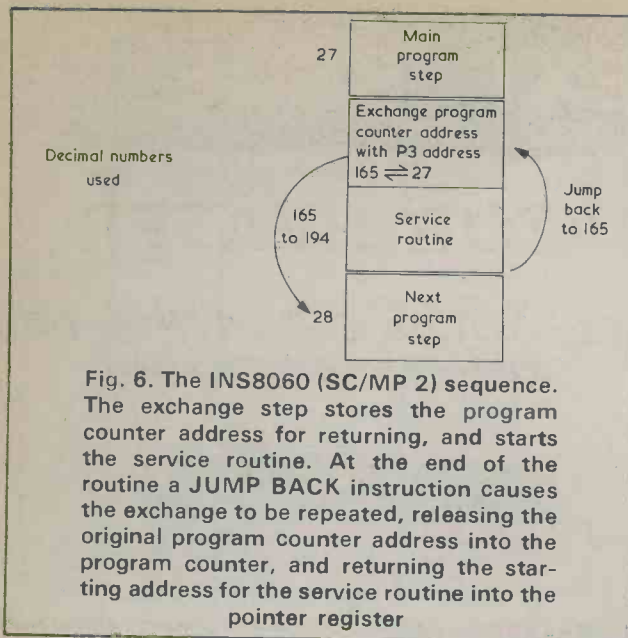

Fig. 6. The INS8060 (SC/MP 2) sequence. The exchange step stores the program counter address for returning, and starts the service routine. At the end of the routine a JUMP BACK instruction causes the exchange to be repeated, releasing the original program counter address into the program counter, and returning the starting address for the service routine into the pointer register

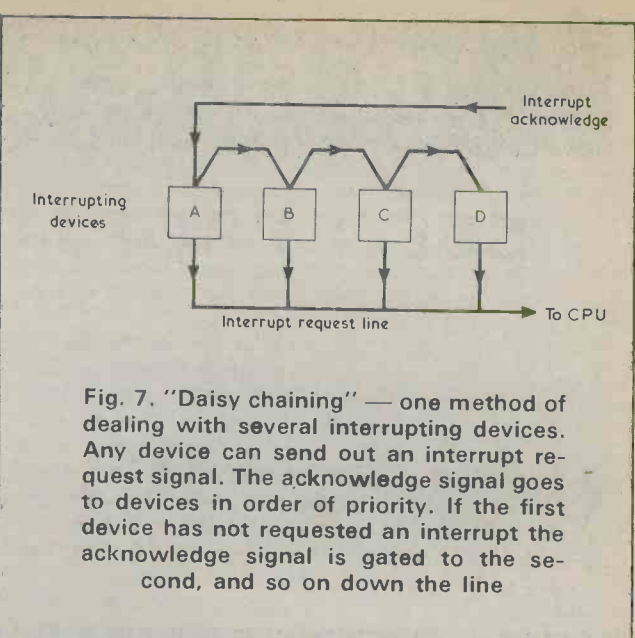

Fig. 7. "Daisy chaining" — one method of dealing with several interrupting devices. Any device can send out an interrupt request signal. The acknowledge signal goes to devices in order of priority. If the first device has not requested an interrupt the acknowledge signal is gated to the second, and so on down the line

This can be done on a first-come-first-served basis, or by having some sort of pre-arranged priority order, so that, for example, device number 6 is always serviced before devices 1 to 5 if there is any conflict.

Next month — more on the status register.

(To be continued)

# WILDLIFE RADIO AID

By P. Manners

As the world shrinks in size with the succeeding decades, many wildlife species become more and more liable to complete extinction unless conservation measures are taken. Fully aware of this situation is the Government of Kenya, and the Kenya Ministry of Wildlife and Tourism has placed a significant order with the Mobile Radio Division of Marconi Communication Systems Ltd., for v.h.f. equipment which will help to stamp out wildlife poaching.

The order, received through the Crown Agents for Overseas Governments and Administrations, is for the supply of both high and low power equipment. Sixteen base stations will be fitted with Marconi RC730 solid state transceivers, more than 350 outstations and mobiles will be fitted with RC625 10-channel f.m. radiotelephones and over 200 transportable lightweight radiotelephones type RC530 are to be supplied for use by foot patrols. Nearly all, if not all, of the equipment will have been delivered by the time these notes appear in print.

The contract entails the complete re-equipping and expansion of the present v.h.f. network to cover all the national parks and sanctuaries for both wildlife and fisheries within Kenya. The new network has to overcome difficulties given by the vast areas involved and the varied physical and climatic conditions. The regions to be protected include tropical coastal plains, lakes, equatorial highlands, large forests and even deserts.

A comprehensive communications system was planned by the telecommunications unit of the Ministry of Wildlife and Tourism, with the emphasis on strengthening the resources of individual national parks by providing communications between the district headquarters, game wardens and patrols, both vehicular and on foot. Due to the harsh environment and long distances, a rugged high power equipment with large battery capacity was required for use by the foot patrols, and the Marconi RC530 transportable was selected as meeting these requirements. In ad-

dition to communications within each national park, selected district headquarters are to be provided with direct communications to the Ministry of Wildlife and Tourism in Nairobi by way of two repeaters on high ground outside Nairobi.

All the equipment supplied employs a high degree of common circuitry and may operate anywhere in the system, allowing a great deal of flexibility as well as aiding maintenance and minimising stocks of spares.

This ambitious project, funded by the Kenya Government and also in part by the U.K. Overseas Development Administration, also includes training and commissioning to ensure that maximum advantage is obtained for this extremely worthwhile contribution to the uphill struggle of Wildlife Conservation. The results will be of benefit not only to Kenya and the hundreds of thousands of tourists who visit the country each year but also, in the long run, to the preservation of all mankind's heritage.



# IN OUR NEXT ISSUE

## SEED PROPAGATOR HEATER



### *ELECTRONIC CONTROL OF SOIL TEMPERATURE*

Heating element switching at pre-selected temperature with very close control.

## MICRO-CURRENT ICM7555 CIRCUITS

### *MEDIUM-LONG WAVE PORTABLE*

IN YOUR WORKSHOP—A Lack of Vision  
SUGGESTED CIRCUIT—The "40-20" Game  
SHORT WAVE NEWS—For DX Listeners  
ELECTRONICS DATA No. 56 — Tracking

## AMPLIFYING INTERCOM

- \*Inexpensive  
2-Way Design*
- \*Call Facility from  
Slave Station*
- \*Unscreened  
"Speaker Cable"  
Gives  
Interconnection*

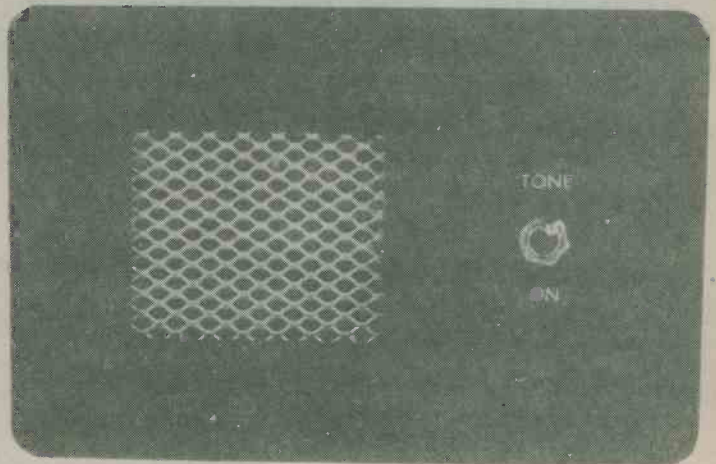

PLUS MANY OTHER ARTICLES

# INFRA-RED INTRU

By M. V. Hastings

## INVISIBLE BEAM PROTECT

## AUTOMATIC CIRCUIT L

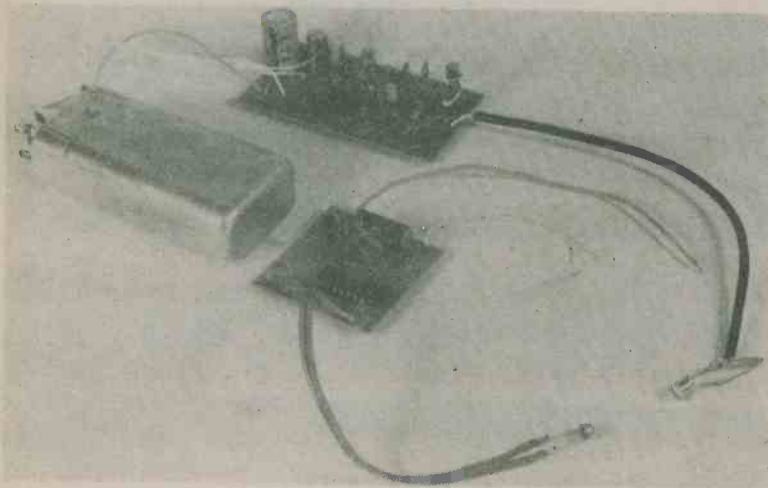

This is an intruder alarm which uses the well-known breaking light beam principle, but in this case the beam is infra-red and is therefore invisible to the human eye. In consequence, the alarm has the considerable advantage that its presence cannot be detected by an intruder, who will therefore make no attempt to avoid breaking the beam as could occur if it consisted of visible light. The use of an infra-red beam incurs slightly higher complexity and cost as compared with a visible light alarm but, even so, the circuits employed are reasonably simple and inexpensive. Apart from its more serious function, the

alarm has considerable novelty and interest value.

The maximum attainable range of the prototype system is about three metres, or 10 ft., which should be adequate for most intruder protection applications. The transmitting and receiving devices could, for instance, be positioned either side of a corridor, door or window. For optimum results, the system should be employed well within its maximum range. There is no need for special infra-red filters or an optical system, as sufficient directivity is given by a built-in lens in both the transmitting and receiving optical devices.

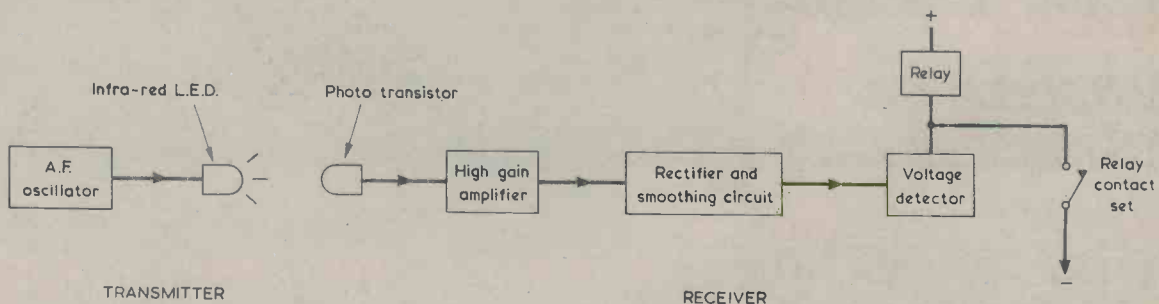

Fig.1. The stage line-up of the infra-red intruder alarm. The modulated beam from the infra-red l.e.d. is picked up by the phototransistor, and the resultant a.c. signal is amplified and detected. If the beam is broken the relay energises, latching on by its own contact set



# UNDER ALARM

## INFRA-RED ETS PROPERTY



## IC ALARM LATCHING



### A.C. WORKING

The basic arrangement of the system is shown in the block diagram of Fig.1. It is not really practical to employ a continuous infra-red beam powered by a d.c. supply, together with a d.c. coupled receiving circuit to detect the presence or absence of the beam, because the output level from inexpensive and readily available infra-red sources is very low. The beam could then be swamped by extraneous light sources, resulting in a very unreliable system.

A better method, and the one adopted here, is to use a modulated infra-red beam. As is shown in Fig.1, this is produced by an infra-red l.e.d. driven by an a.f. oscillator. A receiving phototransistor

produces a weak a.c. signal at oscillator frequency and this is given a considerable amount of a.c. amplification before being applied to a rectifier and smoothing circuit. The rectified voltage is passed to a voltage detecting circuit which is coupled to a relay. In the presence of the signal voltage this is in the de-energised state but, when the infra-red beam is broken, the lack of rectified voltage causes the voltage detector to energise the relay. As soon as it energises, two of the relay contacts close, bypassing the voltage detecting circuit and holding the relay latched on. Thus, the relay remains energised if the infra-red beam becomes unbroken again. A second pair of contacts on the relay actuates an alarm of some kind.

### TRANSMITTER

The transmitter section of the alarm has the circuit shown in Fig.2. Two NOR gates in a CMOS

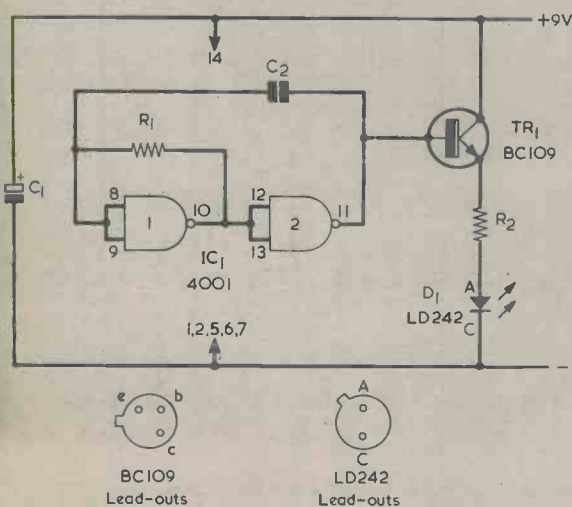
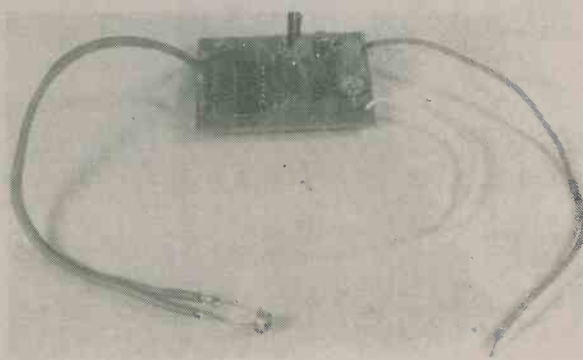
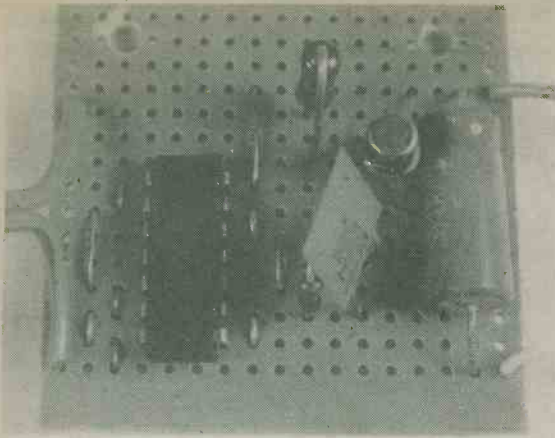

Fig.2. The circuit of the transmitter section



The transmitter board has a twin flex wire connecting to the infra-red l.e.d. The two remaining wires connect to the 9-volt supply



Close-up view of the transmitter board

4001 i.c. are connected as inverters and appear in a standard a.f. oscillator circuit running at around 2.5kHz. The precise oscillator frequency is not of importance. The output of the oscillator connects to the emitter follower, TR1, which in turn drives the infra-red l.e.d., D1, by way of current limiting resistor R2. The peak current flowing in the l.e.d. is about 65mA, giving the circuit a total average current consumption of about 35mA from a 9 volt supply. C1 provides decoupling.

In common with other infra-red l.e.d.'s, the LD242 specified for D1 provides an infra-red output only, and the component does not visibly glow at all. There is thus no need to provide an external infra-red filter. The LD242 is, incidentally, available from Electrovalue, 28 St Judes Road, Englefield Green, Egham, Surrey, TW20 0HB.

## RECEIVER

The receiver circuit appears in Fig.3 and, in this, the modulated infra-red beam is detected by the phototransistor, TR1. R2 is the collector load for the phototransistor and the varying collector current produces a small a.c. voltage which is passed via C1 to the base of TR2. Phototransistors are often employed with no connection made to the base, but a small base bias is provided here by R1. This bias is necessary because under normal operating conditions the phototransistor may well be in almost total darkness whereupon, without the bias, it would pass a very small quiescent current and have reduced sensitivity to the modulated infra-red beam.

TR2 and TR3 are both high gain common emitter amplifiers with capacitive coupling being given by C4. Capacitors C2 and C3 reduce the high frequency response of the amplifier with a consequent improvement in stability and lowering of noise level.

The amplified a.c. signal at TR3 collector is passed via C5 and R7 to a voltage doubling rectifier and smoothing circuit comprising D1, D2 and C6. In the presence of the signal the rectified voltage across C6 is sufficient to turn on transistor TR4. This causes its collector voltage to fall to little more than zero, relative to the negative rail, thereby cutting off TR5. The relay coil, which forms the collector load for TR5, has no current flowing through it and the relay is de-energised.

If the infra-red beam is broken, even very briefly, C6 discharges to a level which causes TR4 to turn off. Current then flows into TR5 base via R8, turning this transistor on and energising the relay Contacts RLA1 close and keep the relay energised even if the infra-red beam is restored again.

D3 is a protective diode which suppresses the

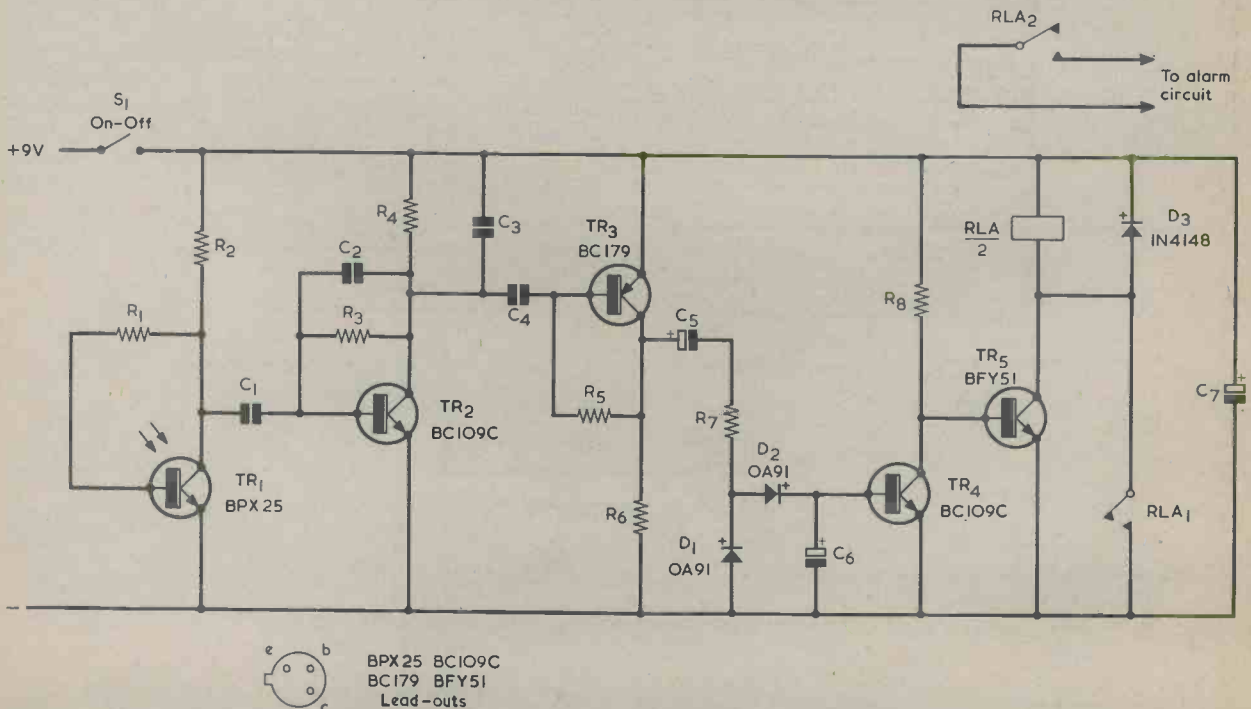

Fig.3. The receiver circuit is more complex. TR2 and TR3 are in a high gain amplifier, with TR4 acting as voltage detector and TR5 as relay driver



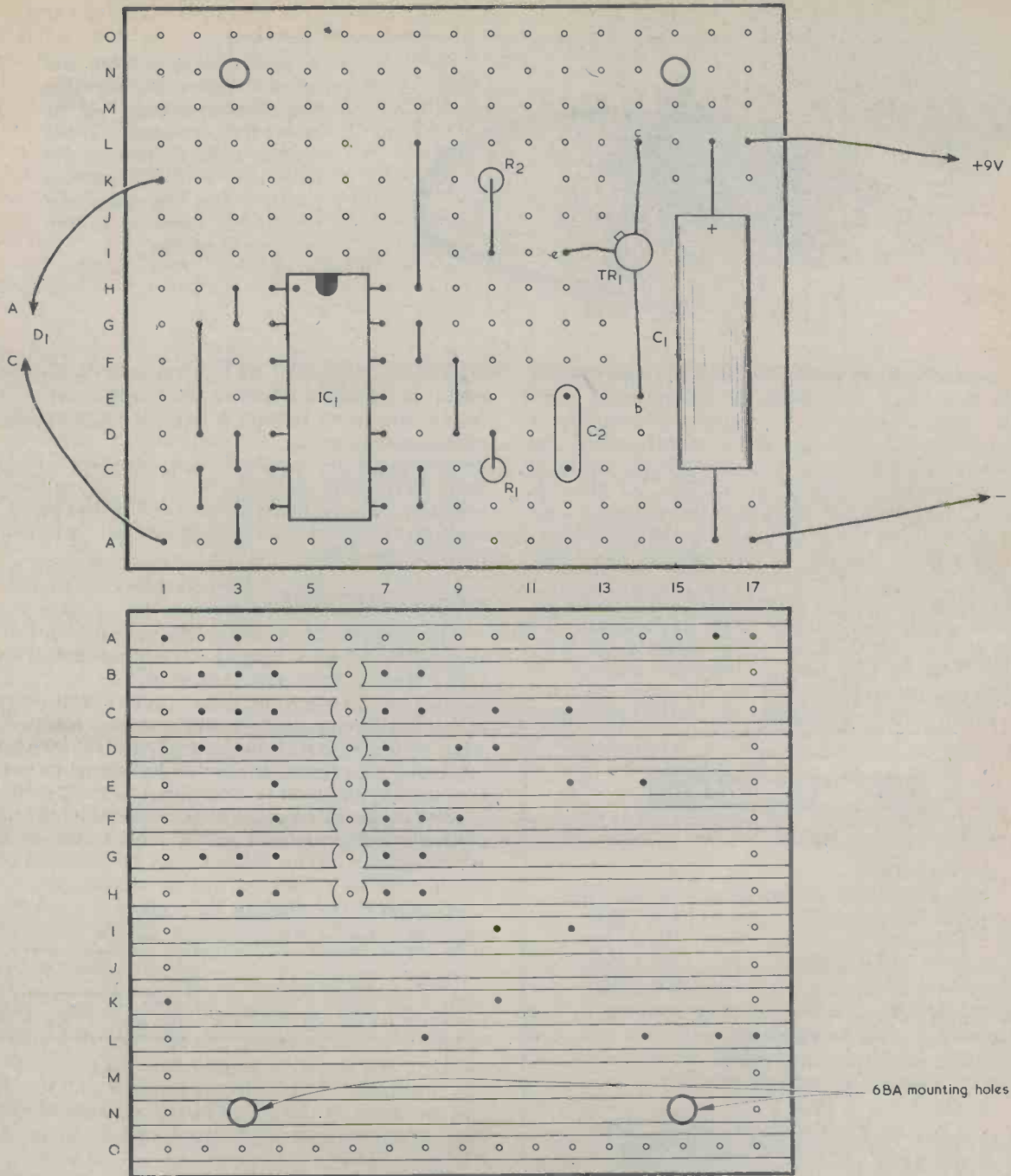

Fig.4. Component layout and wiring details for the transmitter board

## COMPONENTS

### TRANSMITTER

#### Resistors

R1 270k $\Omega$   $\frac{1}{4}$  watt 5%  
R2 100 $\Omega$   $\frac{1}{2}$  watt 5%

#### Semiconductors

IC1 4001  
TR1 BC109  
D1 LD242

#### Capacitors

C1 47 $\mu$  F or 50  $\mu$  F electrolytic, 10 V. Wkg.  
C2 1,000pF ceramic plate

#### Miscellaneous

Veroboard, 0.1in. matrix  
Connecting wire, etc.

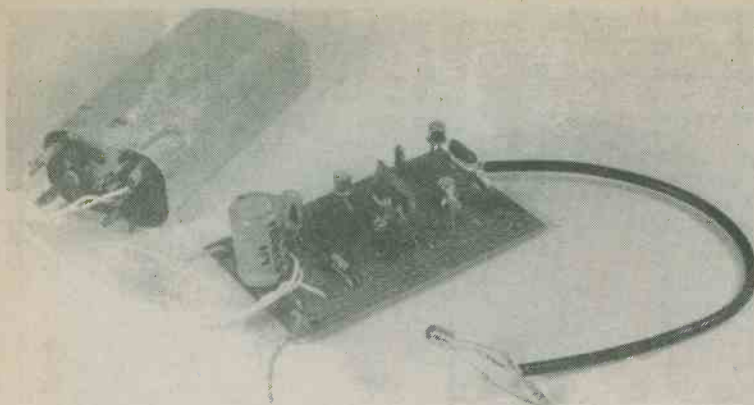

A screened lead from the receiver board connects to the phototransistor and its base bias resistor. Three further leads connect to the relay coil and its latching contact, and the remaining two wires connect to the supply

high reverse voltage which would otherwise appear across the relay coil when it de-energises, and which could damage TR5. Supply decoupling is provided by C7, and S1 is the on-off switch. In security equipment it is normal and advisable to use a keyswitch as the on-off switch, for obvious reasons. The quiescent current of the circuit is only about 3mA from the 9 volt supply, and the relay coil current is added to this when the relay energises.

The relay can be any type having two make contact sets, a coil resistance of 185  $\Omega$  or more and the ability to energise at a coil voltage slightly less than 9 volts. The BFY51 has a minimum hFE of 40 whereupon, theoretically, it should only be used with relay coil resistances of 300  $\Omega$  or more.

However, its typical hFE level is well above 100 and it is doubtful whether the constructor will obtain a specimen having a gain at or near the low minimum figure. Nevertheless, constructors employing a relay whose coil resistance is lower than 300  $\Omega$  may prefer to use a BFY52 in the TR5 position. This is virtually identical with the BFY51 and has the same lead-out layout, but its minimum hFE value is 60.

## CONSTRUCTION

The transmitter section can be built on a 0.1in. matrix Veroboard having 15 copper strips by 17 holes, and it uses the layout shown in Fig.4. Be careful not to omit the seven breaks in the copper strips which appear between the two rows of IC1 pins. IC1 is a CMOS device and can be damaged by high static voltages. It should be left in its protective packaging until it is soldered to the board, and it should be the last component to be fitted. A soldering iron with an earthed bit must be used. Alternatively, an i.c. holder may be soldered to the board and IC1 inserted in this afterwards.

Another 0.1in. matrix Veroboard is used for the receiver circuit, this having 16 copper strips by 30 holes. The board is illustrated in Fig.5. There are only two breaks in the copper strips and these isolate the base circuit of TR2 in order to aid good stability. TR1 connects to the board via a short length of screened cable, the braiding of which connects to the negative supply rail. At the other end the braiding connects to the emitter of TR1. R1 is not mounted on the board but is soldered across the base and collector lead-outs of TR1, as shown in Fig.5.

The housings for the transmitter and receiver boards are left to the constructor. Systems of this general type are usually designed to blend into the surroundings so that they will not be readily spotted by an intruder. Since both the l.e.d. and the phototransistor are connected to their respective boards by short lengths of wire, it is possible for the boards to be hidden. The small l.e.d. and phototransistor can then be mounted in an unobtrusive manner.

The two sections can be powered by batteries, but the fairly high current drawn by the transmitter section would make this rather expensive unless a rechargeable battery were used. The use of rechargeable batteries is, indeed, the most attractive scheme for supplying the units. Two mains supplies could also be used, and the one supplying the receiver section must have a very small well-smoothed output or mains hum could

## COMPONENTS

### RECEIVER

#### Resistors

(All  $\frac{1}{4}$  watt 5% unless otherwise stated)

R1 8.2M $\Omega$ 10%	R5 1M $\Omega$
R2 10k $\Omega$	R6 4.7k $\Omega$
R3 1.8M $\Omega$ 10%	R7 1.8k $\Omega$
R4 4.7k $\Omega$	R8 12k $\Omega$

#### Capacitors

C1 0.01 $\mu$ F type C280
C2 56pF ceramic plate
C3 680pF ceramic plate
C4 0.01 $\mu$ F type C280
C5 6.8 $\mu$ F electrolytic, 25 V. Wkg.
C6 1 $\mu$ F electrolytic, 63 V. Wkg.
C7 100 $\mu$ F electrolytic, 10V. Wkg.

#### Semiconductors

TR1 BPX25
TR2 BC109C
TR3 BC179
TR4 BC109C
TR5 BFY51 (see text)
D1 OA91
D2 OA91
D3 1N4148

#### Switch

S1 s.p.s.t. toggle, key operated

#### Relay

RLA relay with 2 make contact sets

#### Miscellaneous

Veroboard, 0.1in. matrix  
Screened cable Connecting wire, etc.



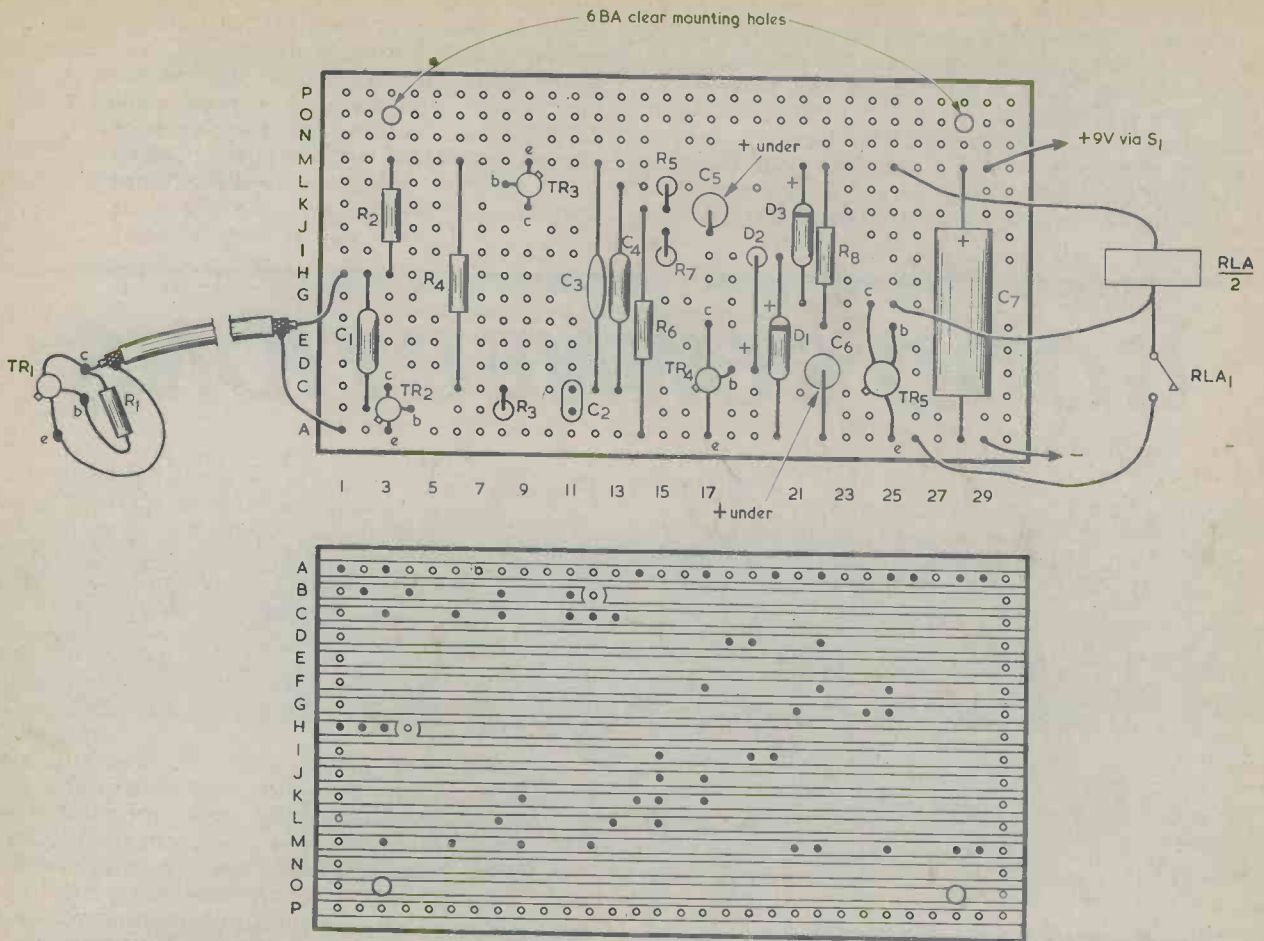

Fig.5. The component and copper sides of the receiver Veroboard. TR1, R1 and the relay are external to the board

cause the unit to latch on regardless of whether the beam from the transmitter is received or not. If the receiver is to be supplied by a mains unit, it is advisable to initially set it up with a battery supply and then change over to the mains supply. Any erratic behaviour due to mains hum will then make itself known.

### ALIGNMENTS

To set up the beam system, the transmitting l.e.d. and the phototransistor need to be directed at each other. The LD242 spreads its infra-red output over a wide area, with maximum intensity directly

to the front. The intensity falls to half at 60 degrees from the maximum intensity direction. The BPX25 phototransistor, which is encapsulated in a TO-18 style package with a lens at the top, is much more directional and has to be pointed directly at the source of infra-red radiation. Before setting up, the connection to relay contact RLA1 should be broken, so that the relay does not latch on when energised.

The l.e.d. needs only to be roughly aimed in the direction of the phototransistor, after which the angle of the phototransistor is adjusted so that it is at the centre of the positions at which the relay just

The receiver board. In the prototype, C7 was a capacitor with lead-outs at one end of the body instead of the axial lead-out component shown in Fig. 5

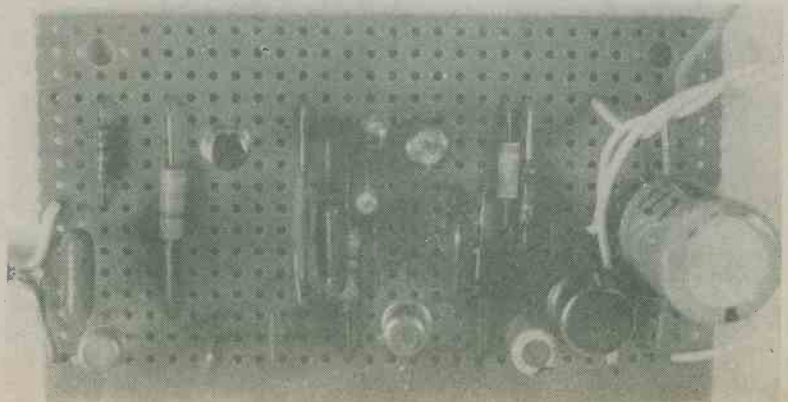

de-energises. After making certain that the relay energises and de-energises reliably when the beam is interrupted and then restored, the connection to relay contact RLA1 can be completed, whereupon the relay will remain latched on after it has been energised. In use, the transmitter section must, of course, always be switched on before the receiver section or the alarm will be triggered inadvertently.

The highly directional properties of the BPX25,

together with the poor low frequency response designed into the receiver amplifier, give the receiver good immunity against being affected by 50Hz mains lighting, which is modulated by the a.c. mains. However, the system should not be arranged such that the BPX25 is aimed directly, or almost directly, at a mains powered light, since this could possibly block receiver functioning or give unreliable results. ■

# GOOD CONNECTIONS

By V. T. Powell

## Make sure your project works first time

Imagine that a constructor commences work on a fairly complex project incorporating twenty resistors, fifteen capacitors, four integrated circuits, a Veroboard panel and a few other parts including an on-off switch and a battery. All the components are 100% serviceable, he makes the cuts in the Veroboard copper strips at the right places and he inserts the component leads in the correct holes in the board. Yet when he has completed the project and connects up the battery it refuses to work.

Why?

Just one of the many connections has been made incorrectly. A single poor connection in a project can completely wreck its chances of functioning.

### CONNECTIONS

Connections in electronic equipment are as important as components. Nowadays, component lead-outs are suitable for soldering in manufacturers' printed circuit boards and, as such, lend themselves admirably to manual soldering with a hand-held iron. Indeed, soldering was never so easy. Against this is the fact that components tend to get smaller and smaller as miniaturisation

proceeds, with the result that extra care has to be taken to avoid incorrect and poorly made soldered joints and connections.

When making soldered joints to tags on potentiometers, tagstrips and similar components, try to ensure that the joint does not end up with a very large blob of solder, like that shown in Fig. 1. Very large solder blobs take a surprisingly long time to cool down to the solid state and there is the risk that the constructor, assuming that the solder has set, may accidentally disturb the soldered lead or leads at the instant of solidification. This can result in a poor joint. A very large blob of solder loses part of its heat by conduction through the wire or wires going into it. If one of the wires is a transistor lead-out the transistor will become heated for a considerable period before the solder blob finally cools off. Modern non-active components are very robust, but even these may also suffer damage due to excessively long heating.

The p.v.c. insulation on connecting wires varies considerably, and some p.v.c. coatings encountered can have a relatively low melting temperature. It is

Fig. 1. If an excessively large blob of solder is left after making a solder joint it can cause undue heating of the components connecting to it

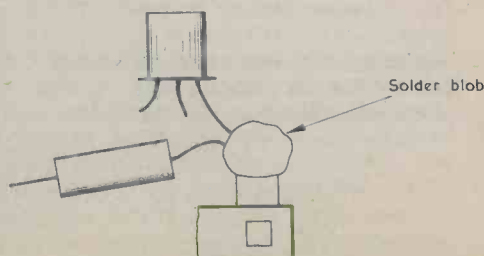



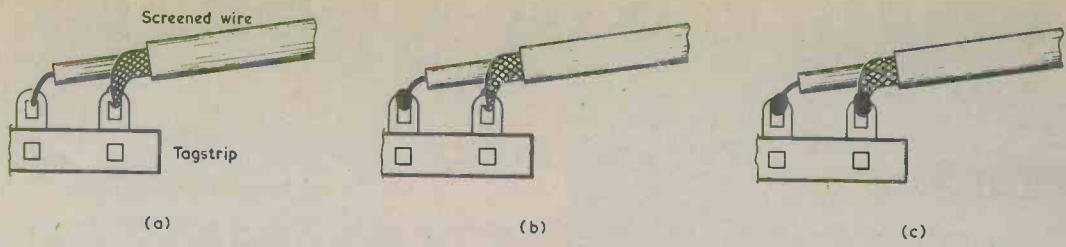

Fig. 2(a). When soldering a thin screened wire to two tags, start by putting the centre lead and braiding in place on the tags  
 (b) Next, solder the centre lead  
 (c). Finally, solder the braiding to its tag, and leave the screened wire undisturbed for a short period

disconcerting to see the plastic peeling away from a wire when its bared end is being soldered, and it is advisable to try and avoid wires with soft p.v.c. covering. Particular care is desirable with thin screened wire. Fig. 2 shows the centre lead of a screened wire connected to one tag and the braiding to another. A good approach here is to put the centre lead and braiding in place on the two tags, and then solder the centre lead to its tag first. Solder the braiding to the second tag after this and then leave the screened wire undisturbed for some thirty seconds or so. If, with the best of intentions, you have nevertheless applied the iron for a little too long to the braiding joint you may have softened the p.v.c. insulation between it and the centre lead. Leaving the wire undisturbed allows the p.v.c. to set hard again and removes risks of later short-circuits between the braiding and the centre lead.

Veropins can cause a minor problem if a soldering iron is applied to the upper end for too long a period. See Fig. 3. Excessive application of the iron causes sufficient heat to travel down the pin to melt the solder underneath. If the pin has been fully inserted the solder underneath will merely reset again after the soldering iron has been removed, but if the pin has been incorrectly inserted it can tilt over, disturbing the solder underneath. If you have to apply an iron to a Veropin for a longer time than usual, always check under the board to confirm that all is still well there.

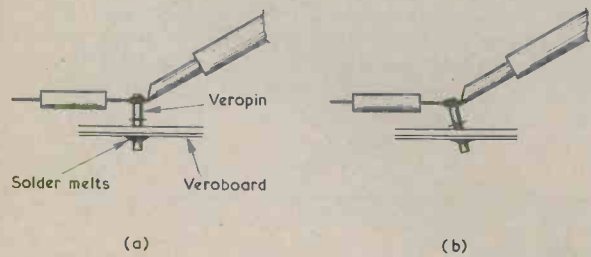

Fig. 3(a). Applying a soldering iron to a Veropin for an excessively long time can cause the solder below the Veroboard to melt

(b). If the Veropin is not correctly inserted in the board it can then tilt over, disturbing the joint below the board and the wiring above it.

### WORKING SURFACE

Working surfaces can be important. It is virtually impossible to keep a wooden bench surface scrupulously clean and it is advisable to avoid soldering miniaturised assemblies directly on such a surface. A good approach is to carry out the wiring on a large white card placed on the bench surface. Odd solder blobs can then be brushed from this into the waste bin, and the card can be thrown away when its surface has become too dirty for further work. Whenever you buy or are presented with a new shirt, you usually also acquire (in company with several hundred pins) a suitable piece of white card.

Wooden working surfaces can, believe it or not, become *conductive* due to ingrained surface dirt, etc. Surprising things can happen with projects having high impedance inputs if the component panel is placed directly on the wood. Place it on a piece of clean card instead.

The author almost always employs i.c. holders in Veroboard projects, and he finds it helpful to solder these in place first. They then form useful markers for determining the positions of the components around them. In fact, it is rather a good idea to work around the i.c. holder pins in numerical order, dealing first with link wires and components connecting to pin 1, then those at pin 2, and so on. In this way you can check against both the layout diagram and the circuit diagram of a project as you proceed. The i.c.'s are, of course, inserted into their holders after all the connections have been completed.

Bulky components such as large electrolytic capacitors are usually best soldered into place last on a p.c.b. or Veroboard. Otherwise, they tend to get in the way of the smaller components around them.

A large magnifying glass can be helpful when looking for solder blobs between strips and other potential sources of trouble on the underside of a completed Veroboard assembly. With very tiny resistors, the glass will also help in deciphering the colour code! A magnifying glass with a glass lens is best for workshop use, as a plastic lens soon gets scratched with handling.

Paying attention to these points can make all the difference between success and failure of a constructional project. To reiterate the message at the beginning, it isn't usually a faulty component which prevents a completed project from working — it's a faulty connection.

# SIMPLE S.W. SUPERHET

Part 2 By R. A. Penfold

## Concluding details on this exceptionally easy-to-build short wave receiver

In last month's issue we examined the circuit of this extremely simple short wave receiver, and then proceeded to the assembly and wiring of the r.f. section. We carry on next to the Veroboard component panel, on which are mounted the parts for the i.f. detector and a.f. amplifier stages.

### COMPONENT PANEL

The components not yet dealt with are assembled on a Veroboard panel of 0.1in. matrix having 17 copper strips by 30 holes, and the layout is illustrated in Fig. 5. This is not a standard size board and has to be cut from a larger piece with a

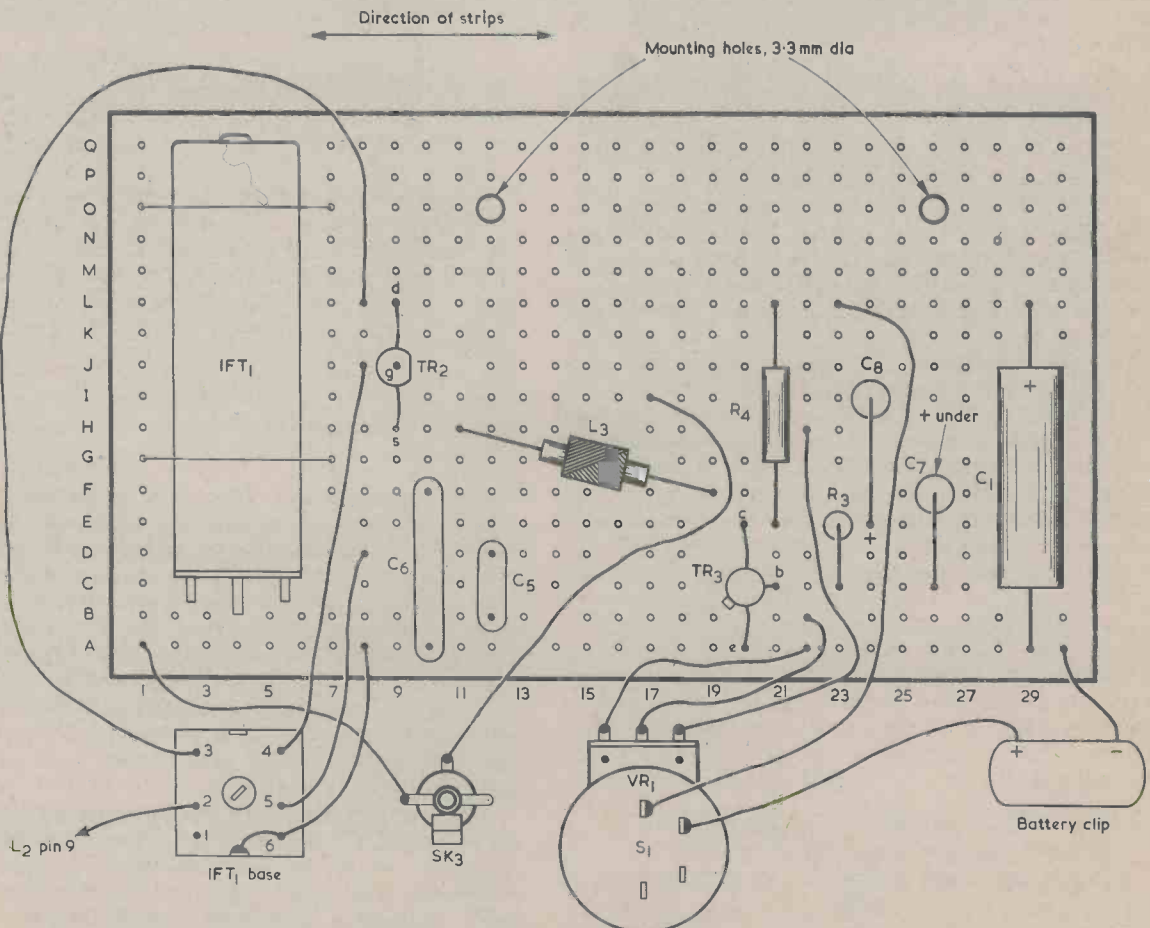
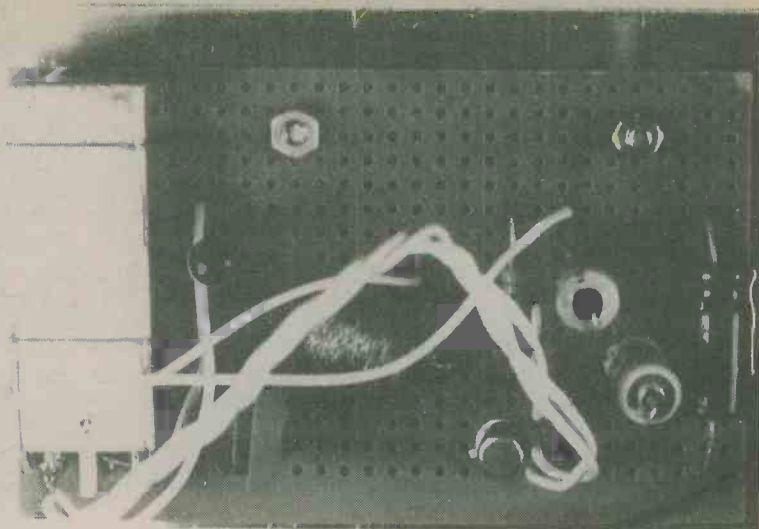

Fig. 5. How the components are wired up on the Veroboard panel. There are no breaks in the copper strips



The Veroboard component panel. To ease the process of wiring and mounting, the single i.f. transformer is fitted on its side rather than vertically



hacksaw. The two 3.3mm. diameter mounting holes are then drilled, and any rough edges on the board are cleaned up to a smooth finish with a file. There are no breaks in any of the copper strips.

IFT1 is mounted horizontally rather than vertically on the board since this makes connections to its tags, which do not fit readily into the Veroboard matrix, more easy to carry out. It is held in place by two lengths of bare tinned copper wire which are soldered to the copper strips at the holes indicated in Fig. 5. One end of each wire is first soldered in place, after which the wire is passed over the can and through the remaining hole with a length protruding. The protruding length is pulled out by a pair of pliers whilst the second solder joint is made. This approach will cause the can to be held tightly against the board. The connections to the i.f. transformer tags should be kept as short as is reasonably possible. Note that there is a connection between tag 6 and the adjacent transformer mounting lug.

The components are next assembled on the panel and this is then wired to the external components before being finally secured to the base of the case. Two 3.3 mm. mounting holes are required in the base and the component panel is mounted by means of two 6BA or M3 screws and nuts, with spacing washers to keep the board underside well clear of the base panel. The three wires to VR1 can be lightly twisted together for neatness. The orientation of the board, and its positioning, can be seen in the photograph of the interior of the receiver which appeared last month.

The board receives its chassis connection by way of the mounting bush and nut of SK3. There will be a second chassis connection along strip 0 of the board to the i.f. transformer screening can if metal spacing washers are employed when mounting the component panel in the case. This second connection is incidental only, and it is the chassis connection at SK1 which is relied on.

The assembly of the receiver is now complete; and an aerial (blue) coil may be fitted in the L1 coilholder and an oscillator coil (white) for the same range fitted in the L2 coilholder. There is plenty of space inside the metal case for the PP3 battery, which may be held in place with a simple home-made clamp, if desired.

## AERIAL AND EARTH

Reasonably good results can be obtained from the set using an aerial which merely consists of a few metres of wire strung around the room. Of course, as is the case with any short wave set, a good outdoor aerial gives better results than a simple indoor one. A long aerial is particularly superior on the low frequency bands which are covered by the Range 3 coils.

A good outdoor aerial is normally in the region of 10 to 40 metres long, and should be hung well clear of buildings and other large earthed objects. It should also be hung high up for maximum signal pick-up.

An earth connection can consist of a metal pipe buried or pushed into the ground at some convenient point, and connected to the receiver via a lead which should be no longer than necessary. An earth connection will not be of much benefit on the higher frequency bands, but it can considerably boost signal strength on the low frequency bands.

## USING THE SET

The desired tuning range is selected by plugging the appropriate set of two coils into the receiver. The coils are supplied with the adjustable iron-dust cores fully screwed down, and they should be adjusted so that about 10mm. of the metal screw thread protrudes from the top of each coil. The set is switched on by means of S1, and then VR1 is gradually advanced. It will possibly happen that a station can be heard which increases in volume until VR1 is taken past the threshold of oscillation. At this point there will be an increase in the noise level together with a whistling sound as the now oscillating detector beats with the carrier of the incoming transmission. In normal use, for the reception of a.m. transmissions, VR1 should be set just below the threshold of oscillation, and this will give optimum sensitivity and selectivity. For c.w. and s.s.b. reception VR1 is advanced just beyond the threshold of oscillation and the tuning control is then carefully adjusted to give the desired c.w. note, or intelligible speech, as applicable.

VC2 is set to that part of the range which is to be searched for stations, after which fine tuning is

carried out using VC3. Tuning is not too critical on the low frequency bands when searching for a.m. signals, and it will probably be most convenient to carry out tuning with VC2, simply ignoring VC3. Under normal conditions VC1 is set to peak the received signals, and if it is adjusted for maximum signal strength at the centre of a band being tuned it is not essential to re-peak it each time a different station is tuned in unless the absolute maximum sensitivity is required. Strong broadcast signals will often overload the set, and then either VR1 may be backed off slightly to reduce sensitivity or VC3 may be set slightly off tune to obtain the same result. In practice the latter will probably be found the more convenient method. Note that it will often be found, particularly on Range 4, that there are two peak settings for VC1, with a different station appearing at each of these peaks. It is the lower frequency peak (given when the vanes of VC1 are meshed together more) which is the correct one, the other peak corresponding to the image response.

The tuning process is more easy to understand if it is remembered that VC2 and VC3, by varying oscillator frequency, select the signal which will be passed into the highly selective i.f. stage. VC1 then ensures that this signal is passed into the mixer at maximum strength.

## I.F. ADJUSTMENT

If it is intended to align the i.f. transformer, this can be carried out after a little experience of operating the receiver has been gained. Only one core of the i.f. transformer has to be adjusted, and it should be borne in mind that the transformer is supplied pre-aligned at the factory so that only a very slight adjustment is required in order to compensate for stray circuit capacitances and the like.

First find a strong station offering a steady signal, tune it in accurately and peak VC1. Then back VR1 well off its normal setting, making the signal just audible. The top core of the transformer (that further away from its tags) is then adjusted for maximum volume of the signal. A proper trimming tool, such as the Denco TT5, *must* be used for adjusting the core, as using say a small screwdriver could easily result in the core being damaged and jammed in place. It is not necessary to adjust the lower core of the i.f. transformer, since both cores are brought into alignment by the procedure just described. As already stated, only slight adjustment of the top transformer core is required to peak sensitivity and the receiver will, in any case, work well without even this adjustment.

(Concluded)

---

# TRADE NOTE

## PEAK PROGRAMME METERS

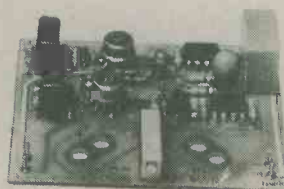
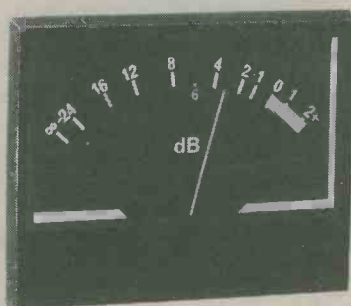

In the past truly professional Peak Programme Metering has been a great expense, few Hi-Fi enthusiasts or semi-professional users have been able to equip with PPM's. The almost universal alternative is the volume unit (vu) meter. Advances in technology have now enabled true bipolar peak-reading meters to become a viable proposition. Soundex are manufacturing a wide range of meters for broadcast and professional users and now complement this range with the PPM 402, which is offered at an extremely attractive price but with all the attributes of a true PPM.

Top Value for money in the Soundex Range of

Peak Programme Meters is the new PPM 402. Half the price of the usual BS 5428 BBC-style PPM, the new PPM has very nearly the same specification. Dynamic range, frequency response and ballistics are similar and so, to avoid confusion, the new Soundex scale is calibrated in decibels, has a red 'overload' region and bold white figures on a black background. The amplifier is a true bipolar quasi-peak pseudo-logarithmic amplifier and meter, complete with instruction leaflet, is £34.95 excl. VAT.

The address of Soundex Ltd., is Park Lane, Broxbourne, Herts.



# VIDEO A.C. COUPLING

By R. Webber

## How some black and white TV sets distort picture brightness levels

You are looking at a Western on a monochrome television receiver. The scene is a shoot-out in daylight, and all parts of the picture seem to have just the right degree of brightness in the range from white through the greys to black. Then the picture changes to a single figure on horseback with a bright sky behind him. For some reason the figure appears to be nearly all black. The scene alters again to a shot of rustlers prowling in the night. But the night doesn't look very dark: quite a light grey instead.

What is happening? There's nothing wrong with the set; it's simply that it has an a.c. coupling between the collector of the video output transistor and the modulating electrode, usually the cathode, of the cathode ray tube. This a.c. coupling, which is given by a series capacitor, causes the picture to be resolved at its *average* brightness level instead of its true brightness level. The a.c. coupling system copes adequately with most reproduced scenes except those which contain a considerable amount of picture information at very bright level or at very dark level. It is only at these two extremes that the shortcomings of the system become noticeable, though even then not everybody notices the fact. A number of 625 line monochrome receivers, including Japanese sets, have a.c. coupling but it does not, in general, significantly detract from the entertainment value of the reproduced programmes.

### CONTRAST AND BRIGHTNESS

To understand more clearly what is happening with an a.c. coupled picture it is first of all necessary to know what the TV contrast and

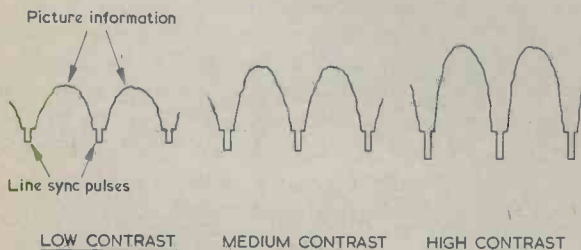

Fig. 1. A television contrast control is effectively a video signal gain control. Relative signal amplitudes are shown here for low, medium and high contrast control settings

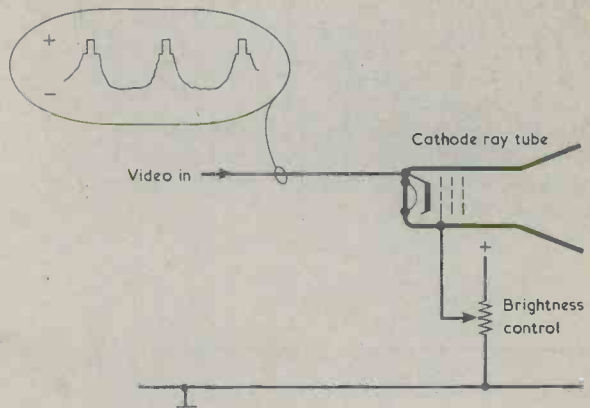

Fig. 2. The brightness control can vary the bias between first grid and cathode of the cathode ray tube. In this example the cathode will be kept positive of the first grid by means of components in the video output stage

brightness controls do. The contrast control is basically a gain control, and it varies the amplitude of the video signal which is passed to the cathode ray tube. Fig. 1 shows the effect on a video signal of low, medium and high contrast control settings.

The brightness control varies the bias on the cathode ray tube. When the tube is cathode modulated it can do this by varying the voltage on the first grid of the tube, as in Fig. 2. The video signal passed to the cathode has picture information going negative and sync pulses going positive. This is the correct polarity for application to a cathode. Making the cathode go negative with respect to the first grid is the same as making the grid go positive with respect to the cathode, and it increases the brightness of the spot on the cathode ray tube screen.

Now, a considerable simplification in receiver design can be effected by coupling the video output transistor collector to the c.r.t. cathode by way of a capacitor, as in Fig. 3. This is a simplified version of the circuit in a current Japanese monochrome receiver. The coupling capacitor has a value of  $0.1 \mu F$  and in this particular circuit it so happens that the brightness control varies the cathode bias voltage, with the c.r.t. first grid being returned to chassis.

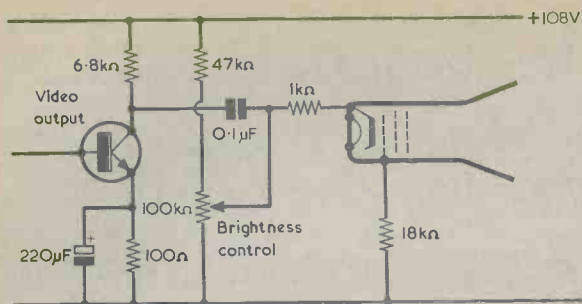

Fig. 3. Simplified version of a current commercial video output circuit. The  $0.1 \mu F$  capacitor provides the a.c. coupling

brightness control is adjusted so that this average voltage appears at the proper bias point along the cathode voltage axis to produce the white to black distribution shown.

The video waveform for a picture having a much higher amount of brightness, and a short dark section in the middle, is applied to the c.r.t. cathode in Fig. 4(b). The average voltage of this waveform is further away from the sync pulses than occurred in Fig. 4(a). The tube bias is not altered, and the  $0.1 \mu F$  a.c. coupling capacitor takes up a new charge which allows the average voltage to be at the same bias point along the cathode voltage axis as before. The result is that the bright sections of the picture are reproduced satisfactorily whilst the darker section in the middle is shifted left to the cut-off point. This is the lone figure on horseback with the bright sky behind him, and Fig. 4(b) shows

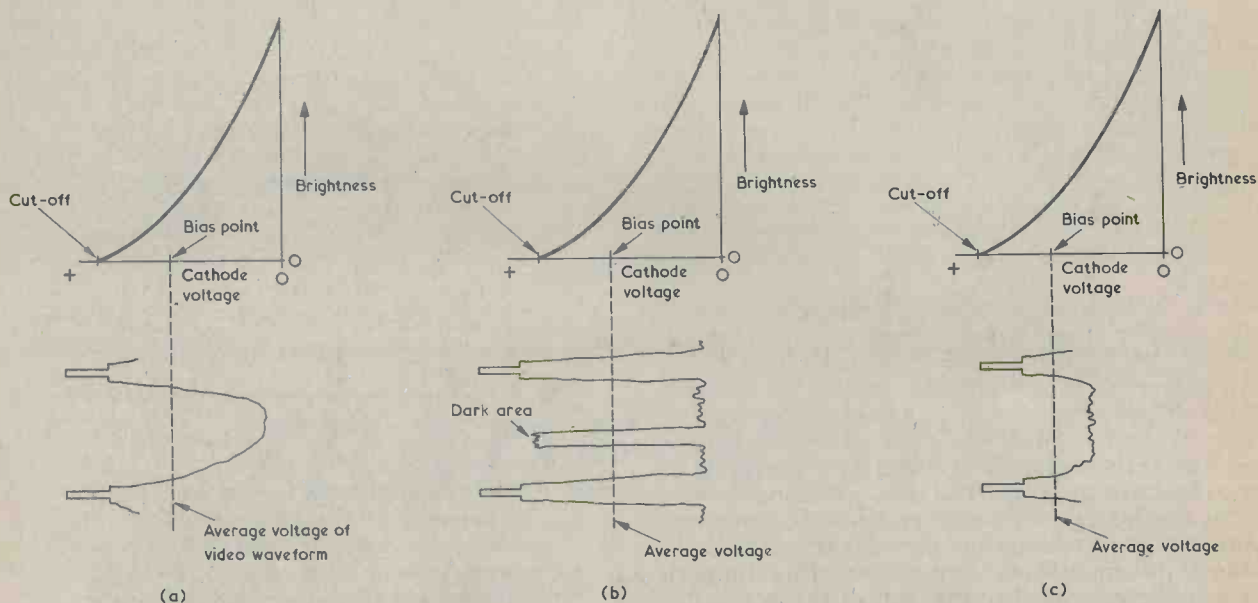

Fig. 4(a). The curve shows the relationship between c.r.t. brightness and cathode voltage, and a video waveform of usual amplitude is applied to the cathode. The brightness control sets a bias point which is taken up by the average voltage of the waveform

(b). The video waveform here has very high amplitude except for a small dark area in the middle. The average voltage now shifts away from the sync pulses, causing the dark area to be at or near the cut-off point

(c). With a signal of small amplitude the average waveform is closer to the sync pulses. The signal is reproduced as light greys rather than dark greys

## BRIGHTNESS-VOLTAGE CURVE

In Fig. 4(a) we introduce a curve which relates c.r.t. brightness to cathode voltage (with respect to the first grid). There is a cut-off point where the cathode is so positive that the e.r.t. spot disappears altogether. Maximum brightness is given when the cathode voltage approaches the potential of the first grid. Picture information for a scene having average brightness is applied to the cathode, and it will be seen that it takes the brighter parts of the picture close to the peak white section of the curve, with the sync pulses being mostly at or beyond the cut-off point. (The sync pulses will not affect the picture as the tube blanks off when they are present.)

The video waveform of Fig. 4(a) has an average value, which is shown in broken line, and the

why he appears to be nearly all black.

The night-time rustling scene gives the video waveform with reduced amplitude which is shown in Fig. 4(c). The average voltage is now much closer to the sync pulses, and the a.c. coupling capacitor allows it to once more appear at the same bias point along the cathode voltage axis. As you can see, all the very dark parts of the picture will appear as light greys.

And that's what happens in a monochrome set with a.c. coupling. Most monochrome sets have d.c. or "partial d.c." coupling which ensures that the sync pulses always remain at or near the cut-off point on the c.r.t. brightness curve. If you have a set with a.c. coupling there isn't a great deal you can do about it, and it would certainly be very difficult and, indeed, unwise to attempt to modify it.



# The "Watersport" Medium-Long Wave Portable

— Part 2 By Sir Douglas Hall, Bt., K.C.M.G.

## Concluding details covering the construction and operation of this unique design

### CONSTRUCTION

Before commencing the construction it is advisable to obtain the speaker to be used. This is because different speakers meeting the main requirements for the receiver can have marginally different dimensions, and these may incur amendments to the dimensions of the parts which make up the receiver. In general it will be the depth of the speaker, i.e. the distance between the front of its frame and the back of its magnet which will qualify "chassis" front dimensions. It is also necessary for a PP9 battery to be fitted below the speaker magnet in the manner shown in the photograph of the rear of the receiver, and this can be achieved if the diameter of the speaker magnet is not greater than  $2\frac{1}{4}$  in. After the constructional details have been read, a check should be made to see whether the battery can be accommodated. If not, the receiver "chassis" height or depth should be amended as necessary.

Construction starts by cutting out a rectangular piece of  $\frac{1}{4}$  in. plywood to the dimensions shown in Fig. 2. The  $3\frac{1}{2}$  in. dimension should be equal to or greater than the depth of the speaker plus  $\frac{1}{4}$  in. (for the front panel), and if necessary this dimension should be increased accordingly. a  $\frac{3}{8}$  in. hole is drilled at the exact centre of the rectangle, and VC1 is mounted at this hole. Next cut down the 28-way tagstrip to give a strip having 21 tags and a hole at each end for mounting. It will be necessary to drill out one or two tags to obtain the mounting holes, and the strip then has the appearance shown in Fig. 2. The strip is secured to the plywood by means of two woodscrews, 4BA nuts being passed over the screws between the strip and the plywood to act as spacing washers and thereby space the tagstrip underside from the wood.

The small components shown in Fig. 2 are then soldered up on the tags. T1 and T2 are mounted by soldering their mounting lugs to the tags indicated, and their physical positioning is as illustrated. It is important that the lugs are soldered to the correct tags as the transformer metal frames complete part of the receiver circuitry. The remaining components should stand over the tagstrip, and none of these should be outside the periphery of the plywood rectangle. They are shown spread out in the diagram for clarity. When the wiring is complete, put the plywood panel on one side for the time being.

Next, cut out the section shown in Fig. 3(a). This, again, consists of  $\frac{1}{4}$  in. plywood. After this, there are three coil units to be made, the first being shown in Fig. 3(b) and the other two in Figs. 3(d) and (e). All these coils are wound on formers which pass over

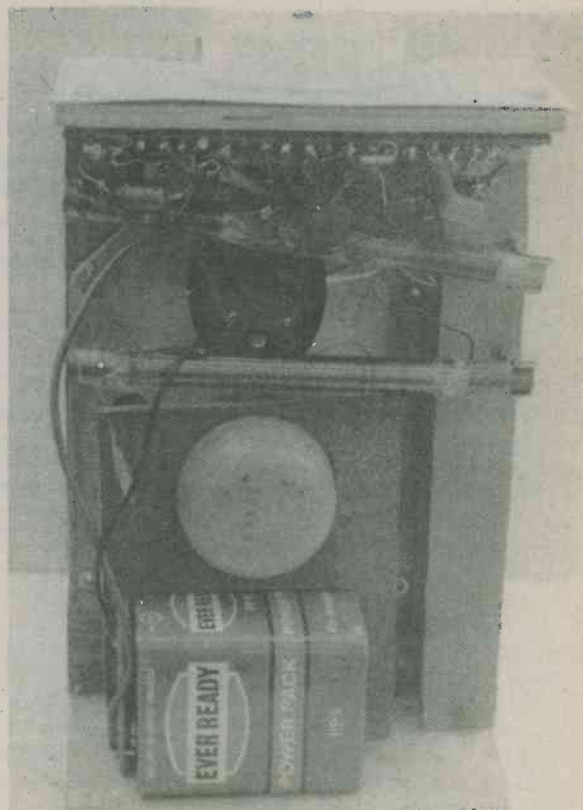

The PP9 battery is positioned below the speaker and is held in place by a plywood item which will be described next month

ferrite rods, and these formers can be made up with Fablon. For Fig. 3(b) a piece of Fablon measuring 4 in. by 3 in. is required, for Fig. 3(d) the Fablon piece should be  $5\frac{1}{4}$  in. by 3 in., and for Fig. 3(e) it should be  $5\frac{3}{4}$  in. by 3 in. Each former is made up by removing a  $\frac{1}{2}$  in. strip of the paper backing along one long edge, and then wrapping the Fablon around the ferrite rod with which it will be used so that the exposed adhesive is rolled on last and secures the tube. The former for Fig. 3(b) should be made such that its ferrite rod is an easy sliding fit inside it. With the other two coil units the fit may be a little tighter.

Wind the coils as indicated in the diagrams. All are close-wound and all are wound starting at the top end. The starts of L6, L4 and L2 are all  $\frac{1}{4}$  in. from the top of the former, and there is a separation of  $\frac{1}{4}$  in. between L4 and L3 and between L2 and L1.

A  $\frac{1}{4}$  in. length of round wooden dowelling is in-

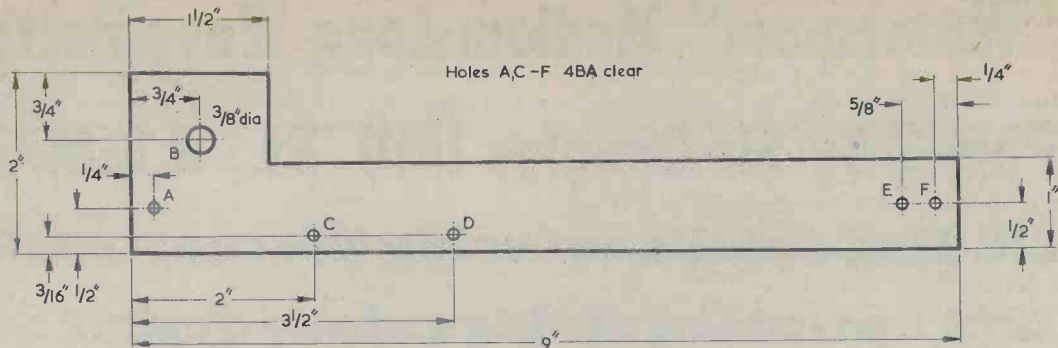

(a)

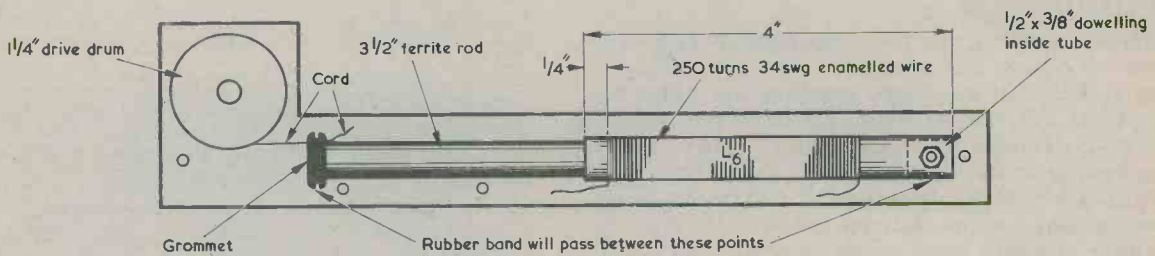

(b)

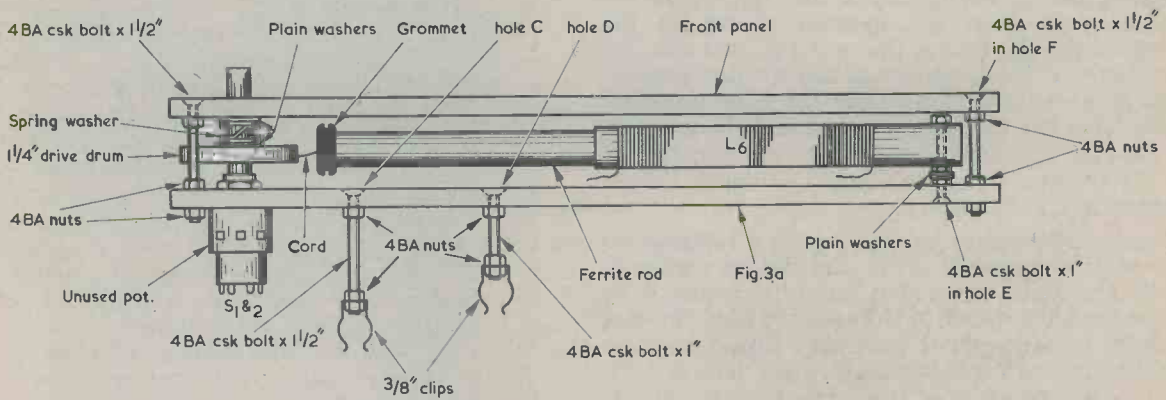

(c)

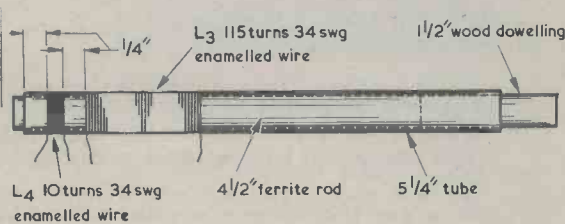

(d)

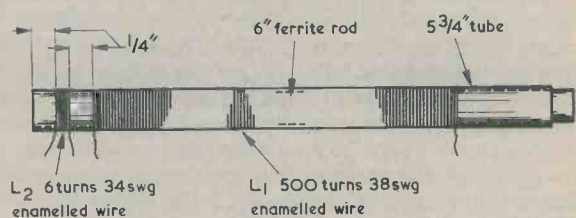

(e)

Fig. 3(a). Plywood item on which are mounted the wave trap coil and the assembly which controls its inductance

(b) How the ferrite rod is caused to move in and out of the coil

(c) Side view illustrating the manner in which the item of (a) is secured to the receiver front panel

(d) Details of the medium wave coil unit  
(e) The manner in which the long wave coil unit is made up

serted at the bottom end of the former of L6, a layer or two of Sellotape being wound round it if necessary to give a tight fit. A 4BA clear hole is then drilled through the former and the dowelling, at the centre of the dowelling and this takes a 1in. countersunk 4BA bolt passed through hole E of Fig. 3(a) in the manner il-

lustrated in Fig. 3(c). This last diagram includes the front panel of Fig. 4 (which has not yet been made and which will be described next month) and the left hand edge of Fig. 3(a) is flush with the corresponding long edge of the panel. The potentiometer with the 2-pole switch is mounted at hole B, and its spindle will pass through a corresponding



hole in the front panel. Fitted over the spindle is the 1½ in. drive drum and washers as shown. The spring washer is held between four or six plain washers and will be compressed when the front panel is fitted, to introduce a degree of stiffness to the movement of the spindle. After the front panel has been fitted, a nylon cord from the drive drum will pass over the upper 1½ in. countersunk 4BA bolt shown and be secured to the upper end of the 3½ in. ferrite rod by trapping it under a ⅜ in. grommet, a turn or two of Sellotape being used if necessary to help it to be gripped tightly. The assembly is adjusted so that, when the potentiometer spindle is turned so that S1 and S2 are just switched on the rod is resting at the bottom of the Fablon tube. There will then be a little slack in the cord when the potentiometer switch is turned off. Turning the potentiometer spindle clockwise will draw the ferrite rod out of the coil. A thin rubber band is passed round the bottom of the coil former and the top of the ferrite rod to ensure that the rod is drawn into the former when the potentiometer spindle is turned anti-clockwise. This rubber band is not shown in the diagram.

Before concluding on the subject of the coils it should be noted that a 4½ in. ferrite rod is inserted into the former for L3, L4, taking up the approximate position shown in Fig. 3(d). At the end remote from L4 a 1½ in. length of ⅜ in. wooden dowelling is inserted. Again, a turn or two of

Sellotape on the dowelling may be required to give a tight fit. The coil unit will be mounted by fitting the projecting dowelling into a suitable spring clip. A 6 in. ferrite rod is fitted into the former for L1, L2, a small part of this rod protruding at the end remote from L2. The projecting piece of ferrite rod fits into another clip for the mounting of this coil unit.

## FRONT PANEL

The final items to be fitted to the piece of Fig. 3(a) are two 4BA countersunk bolts, one 1½ in. long passing through hole C and the other, 1 in. long passing through hole D. These are secured with nuts, as shown in Fig. 3(c). At the bolt ends are two spring clips which take the projecting wooden dowelling for the L3, L4 assembly and the projecting ferrite rod of the L1, L2 assembly. The author employed ⅜ in. Lektrokit spring clips type LK2721 but these are now difficult to obtain on the home constructor market. Any other spring clips, such as Terry clips, capable of holding a ⅜ in. diameter rod will be suitable as also would plastic clamps. A metal clamp may not be used if it will constitute a shorted turn around the wooden dowelling or ferrite rod.

Fig. 4 gives details of the front panel, as seen from the rear. This shows the assembly of Fig. 3(b) in position and the two coil units clipped in place. First cut out the front panel itself, which consists of ¼ in. plywood, and drill two 4BA clear holes to match holes A and F in Fig. 3(a). As was stated last month, the item of Fig. 3(a) is turned over so that its bottom side is now on the right and, in Fig. 4, is flush with the right hand side of the front panel. Next drill a ¼ in. hole in the front panel to take the spindle of the potentiometer to which the drive drum is fitted. Drill a ⅜ in. hole symmetrically opposite for mounting VR1, and another ⅜ in. hole in the centre for VR2/S3. Mark out a suitable aperture for the speaker, as shown in broken line in Fig. 4, and then cut out this aperture. The speaker should take up the position illustrated, with its bottom end flush with the bottom of the panel and its left hand side flush with the left hand side of the panel. It is mounted by means of four short woodscrews.

Assemble the item of Fig. 3(a) to the front panel, using two 1½ in. 4BA countersunk bolts with nuts, as was shown in Fig. 3(c). Next lace up the nylon cord to the drive drum and the ferrite rod for L6 in the manner which was described last month. When this is mechanically correct, fit VR2/S3 and VR1. Fit the medium and long wave coil units to their respective clips as indicated in Fig. 4. The reason for using dowelling at the end of L3, L4 is that if the ferrite rod itself is fitted to the clip there can be an unwanted coupling through the clip-mounting bolt to the ferrite rod for L6. No coupling problems arise on long waves because the wave trap circuit is then switched out of use.

Wire up as shown in Fig. 4. Before connecting to S1, S2 and S3 confirm with an ohmmeter the actual tags which correspond with each switch section, as their relative positioning may differ from that shown in the diagram. Note that a spare switch tag on VR2/S3 is used as an anchor tag, as also is one of the tags of the potentiometer associated with S1/S2. Next, mount the component panel of Fig. 2 to the top of the front panel in the manner shown in

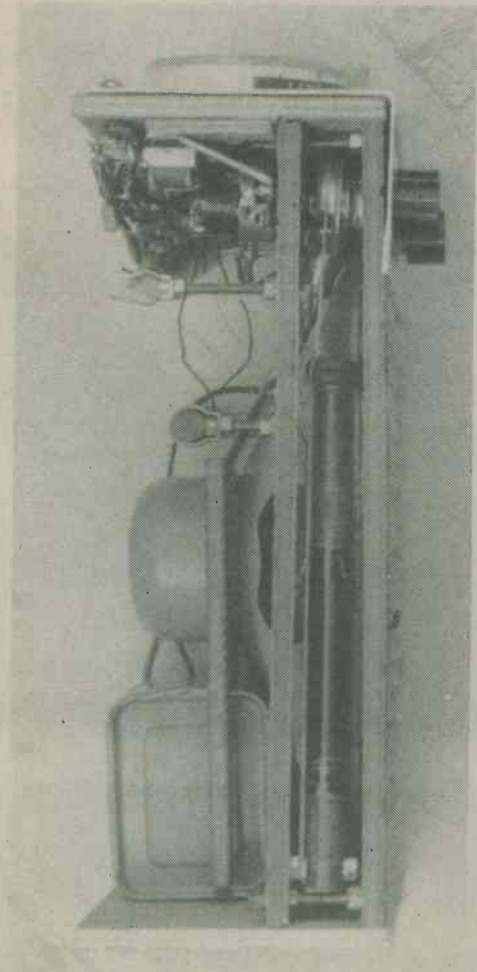

Side view illustrating the wave trap coil in which the 3½ in. ferrite rod slides

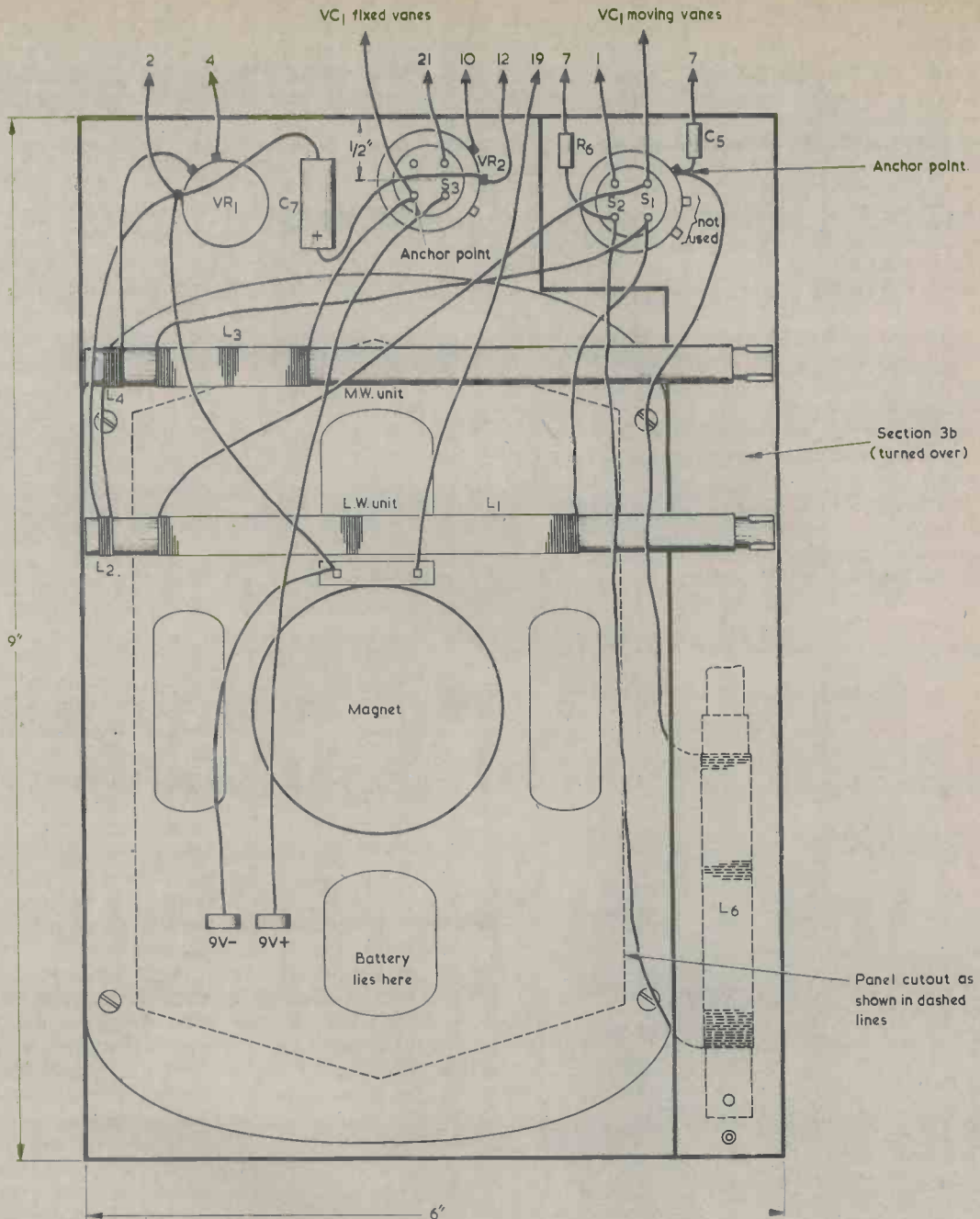

Fig. 4. The front panel viewed from the rear, showing relevant dimensions and wiring. The numbers at the top refer to the tags in the 21-way tagstrip of Fig. 2

Fig. 2, using woodscrews. Complete the wiring between the front panel components and the tagstrip on the component panel. The numbers at the top of the leads in Fig. 4 correspond with the tags in the tagstrip, counting from the left.

A suitable  $\frac{1}{4}$  in. plywood base for the receiver is shown in Fig. 5(a) and the bottom of the front panel may be screwed to this as indicated. The front of the panel is  $\frac{1}{16}$  in. in from the front of the base to leave space for speaker gauze. Also screwed to the base is the bottom end of the item of Fig. 3(a). The PP9 battery stands on the base and is held steady by the piece of  $\frac{1}{4}$  in. plywood shown in Fig. 5(b). The

circular hole here is a push fit over the speaker magnet and this item is not screwed into position but is simply pushed over the battery and the magnet. The  $5\frac{1}{4}$  in. height dimension may need to be modified to suit some speakers.

#### OPERATION

When the wiring has been completed the set is ready for checking. Temporarily fit a large knob to VC1 to enable it to be adjusted. Insert a multimeter switched to a high current range (because it is testing a newly completed circuit and a wiring error



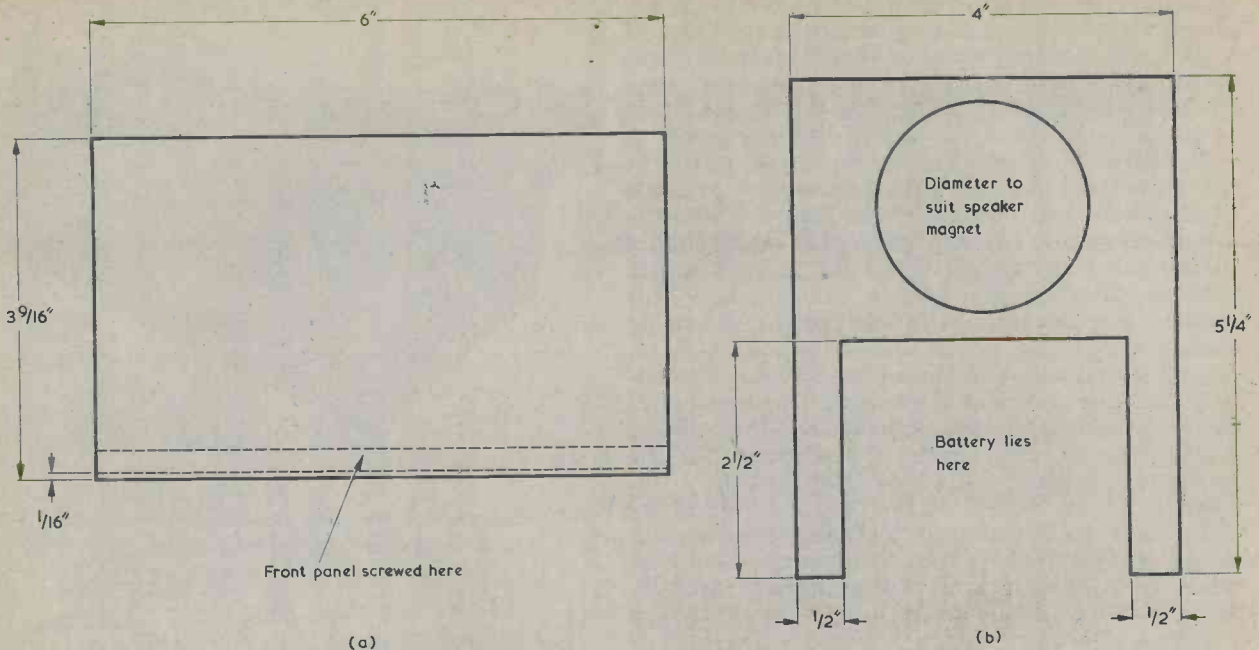
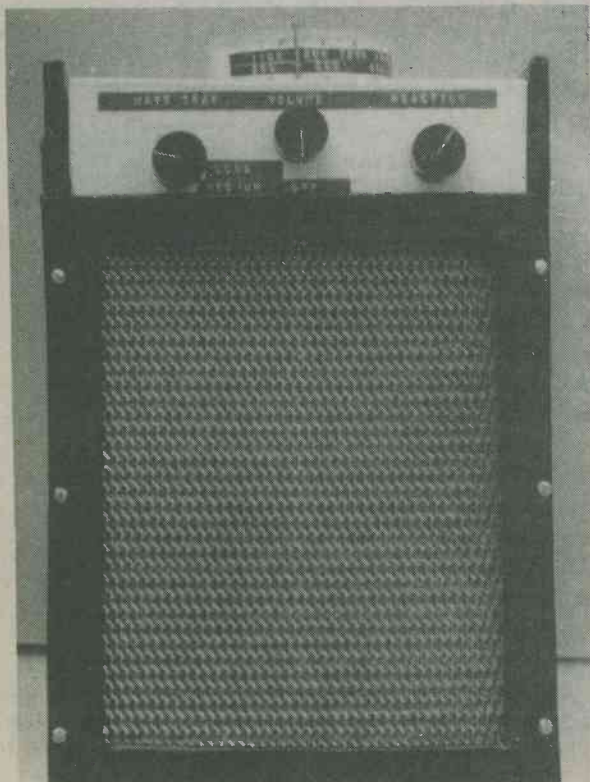

Fig. 5(a). The base of the receiver. The bottom of the front panel is screwed to this as indicated. Another screw (whose position is not shown here) passes through the base into the bottom of the item of Fig. 3(a)

(b). This item, made of 1/4 in. plywood, passes over the speaker magnet and holds the battery in place



The three front panel controls are arranged symmetrically above the speaker gauze

could cause a high current to pass) in series with one of the battery leads and switch on at S3. If the meter reading indicates that it is safe to do so, select a lower current range and check the current consumption. This should be approximately 12mA, the actual current depending upon the characteristics of the transistor employed for TR3. If all is well, switch off, disconnect the meter and connect the receiver to the battery properly.

Adjust the wave trap control so that S1 and S2 are just switched on and switch on again at S3. Set VR2 for a reasonable volume level and then adjust VR1 until a hiss denotes oscillation. It should be found, provided the wave trap is set with its ferrite rod fully inserted in the coil, that hardly any adjustment to VR1 is needed to maintain the most sensitive condition over nearly the whole medium wave band whilst tuning the receiver by means of VC1. At the author's home in South Devon some 30 stations are available on the medium wave band without adjustment to VR1 once it has been correctly set. Next check performance on long waves. On this waveband VR1 may require a different setting for optimum reception along the band.

Return to medium waves with the wave trap ferrite rod fully in its coil. Next choose a powerful station — there may well be one which is swamping its near neighbours — and adjust the wave trap. It will be found that there is a finely adjusted position at which the powerful station cannot be heard at all, or only very faintly. It will now be necessary to advance VR1 in order to obtain maximum sensitivity at points on the dial close to the silenced station and some readjustment of the tuning control will also be required. Also, with the wave trap

in action the reaction control will have to be adjusted more at different frequencies on the band. If a station is required which is very close in frequency to the silenced one it may be necessary to tune the trap slightly off tune from the offending station to prevent the required station being trapped as well. Mark on the panel the exact correct setting of the wave trap for the offending station and the process will then be easy in the future. When the offending station itself is required it can probably be brought in by a slight readjustment to the trap without altering the tuning control, and this method may sometimes be convenient. When no station very close to the offending station is required it may also sometimes be convenient to adjust the trap so that the strength of the powerful station is reduced to the same level as that offered by stations in other parts of the range, for the reception of which VR1 has been critically adjusted.

In case the procedure just described should sound complicated, it should be emphasised that when the wave trap is set with its ferrite rod fully into the coil the receiver may be operated as though it were a superhet once the correct reaction setting has been found for each band. With the wave trap in action, tuning is a slightly more skilled operation, but the complete taming of unwanted powerful stations has to be experienced to be believed!

If instability or "grunting" takes place at any setting of the trap there is positive feedback between it and the medium wave coil. The connections to L6 should then be transposed. The connections to L6 should similarly be transposed if the



Side view showing details of the medium and long wave coil assemblies and the components on the 21-way tagstrip

trap does not appear to be fully effective in silencing the unwanted station or stations. Also, try the effect of slightly rotating the clip which holds the medium wave coil. Results may be improved if the L4 end of the medium wave coil is taken closer to VR1 or to the L2 end of the long wave coil unit.

## FINISHING TOUCHES

The top panel of the chassis and the top 2 in. of the front panel should be covered by a card which is itself covered in Fablon of a suitable colour. The card is bent through a right angle and fitted under the control knobs. A large circular knob is needed for the tuning control. If desired, a large circular control assembly fitted with a tuning scale can be home-made and used here. Knobs with a diameter of about  $\frac{3}{4}$  in. are suitable for the other three controls.

The case is shown in Fig. 6. Dimensions shown here should be taken as a guide only as they assume that the receiver "chassis" has been made exactly to size, and in practice the case should be made up to suit the receiver as constructed. The pieces in Fig. 6(a) and (c) are of  $\frac{1}{4}$  in. plywood and show the inside of the left and right hand sides of the case, looking at the back. The frame for the front, shown in Fig. 6(b), is also viewed from the back, and consists of  $\frac{1}{8}$  in. s.r.b.p. or hardboard. These pieces are covered with suitable Fablon and screwed together. Note that the tops of the two sides are slightly higher than the top of the "chassis". The back is made of  $\frac{1}{4}$  in. pegboard, has the same width as the front frame and has a height extending up to the top panel of the receiver. It is screwed to the two sides. The case may be lowered over the "chassis". A stiff wire handle is made up as illustrated in Fig. 6(d) and is covered with suitably dimensioned plastic sleeving except for the handle ends. These bare ends are slipped into the two holes at the top of the sides, whereupon they should be just under the top panel. The wire ends hold the case in position and allow the whole receiver to be picked up by the handle.

Why "Watersport"? Wave Trap SPOnTaflex!

(Concluded)

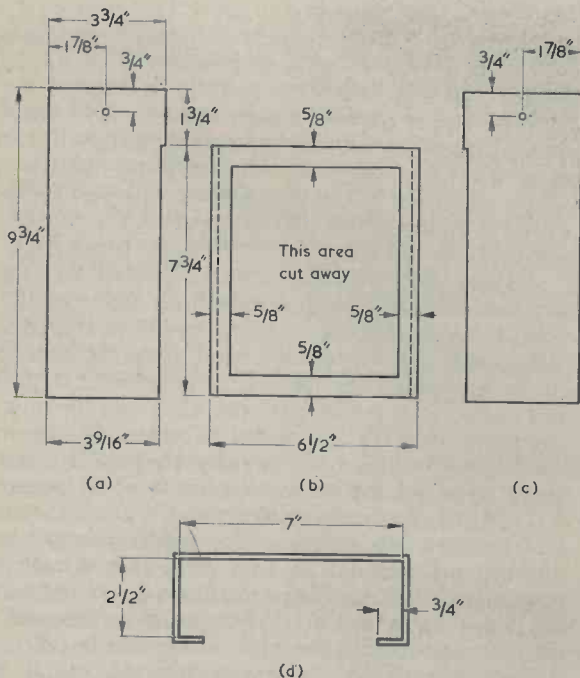
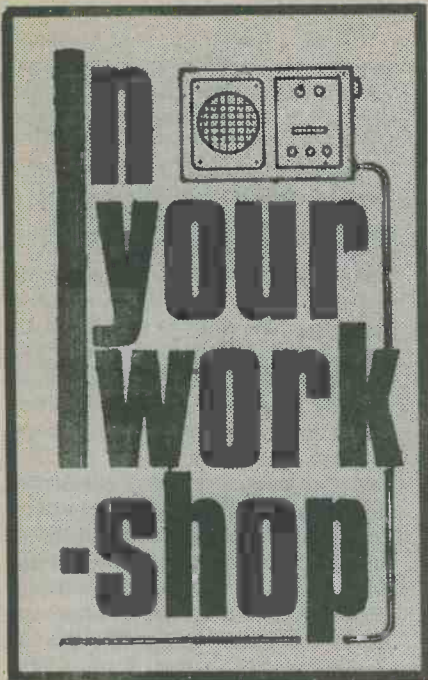

Fig. 6(a)(b)(c). The two sides and front panel of the case as viewed from the rear. Dimensions are for guidance only, and the actual dimensions should be taken from the receiver as built

(d). The handle for the receiver case is made from stout wire covered with plastic sleeving





# BEGINNERS PLEASE!

Perennial questions on resistors and capacitors

## STARTING FROM SCRATCH

Smithy suppressed a smile and refrained from remarking that he himself, for more years than he cared to remember, had been answering technical question after technical question put to him by his avidly eager assistant.

"Just now, there seems to be quite a rush of people who are starting to take up radio and electronics as a hobby," he commented. "A mate of mine at Data Publications tells me that they're getting quite a lot of letters from readers these days asking questions about very simple matters such as fixed resistor tolerances and wattages and things like that."

"That's exactly what's happening with young Septimus. He started off last night about resistors. He's been looking at some constructional designs in magazines and he's got himself in a right old twist about resistor tolerances."

"That's to be understood," said Smithy. "Indeed, it must be really confusing for someone who is starting right from scratch to enter a world where things like resistors have different tolerances."

"That was my nephew's reaction," said Dick. "I had quite a job trying to explain it all to him."

"I think," said Smithy slowly, "that the best way of looking at resistors is to say that each resistor specified in a magazine circuit should meet three basic requirements. First of all, it should have the correct resistance in ohms, kilohms or megohms. Secondly, it

should have an acceptable wattage rating, and thirdly it should have an acceptable physical size."

"Let's deal with the correct resistance first."

"All right," said Smithy obligingly. "Now, a factor which separates electronics from most other engineering disciplines is that very many electronic circuits will work perfectly satisfactorily when the components in them have values which are only approximately equal to the design centre figures. This is the case with resistors and these are nearly always employed with tolerances on value of 5% or 10%.

"That's the first thing that bugged Septimus," said Dick. "He wanted to know if 5% resistors could be used where a published design quoted 10% resistors, or whether it should be the other way round."

"That's an oldie," grinned Smithy. "And the answer is that it's always in order to use a 5% resistor where a 10% resistor is called for, but that a 10% resistor should not be used when a design specifies 5%. This is easy enough to understand if we take a simple example. Let's say a circuit employs a 100  $\Omega$  10% resistor in one position. This means that the circuit will work happily with any resistor whose actual value lies between 100  $\Omega$  plus 10% and 100  $\Omega$  minus 10%. Now, 100  $\Omega$  plus 10% is 110  $\Omega$  and 100  $\Omega$  minus 10% is 90  $\Omega$ , so all that is required of the resistor is that its actual value should be between 110  $\Omega$  and 90  $\Omega$ . Let's say that the person building the circuit finds that he has

"It's my darned family, Smithy." Smithy grunted sympathetically, then drank deeply at his morning break tea.

"What it is is that they're always on to me to do things for them. Like wire up electric lights or fix radios."

This was a common complaint on the part of Smithy's assistant. Dick had the misfortune of possessing far more aunts, mostly of the maiden variety, than any reasonable person should be expected to have.

"Who is it this time?" asked Smithy. "Your Auntie Eff?"

The lady in question, referred to in Dick's family with raucous merriment (to Dick's complete mystification) as "Ineffable Eff", imposed a rule of iron sustained by the fact that she represented what could be described as Great Expectations.

"No, it's not her," replied Dick, heaving a sigh of relief. "It's Septimus."

"Septimus?" queried Smithy, puzzled. "Surely even your family couldn't include an aunt called Septimus."

"It's not an aunt, it's a nephew of mine."

"Ah," said Smithy, satisfied with this explanation. "Well, a nephew should balance out all the aunts. What's he been up to?"

"He's started to take an interest in radio and he keeps asking me questions all the time. D'you know, Smithy, he had me trapped for nearly two hours last night, doing nothing else but pick my brains about electronics. Just imagine it — answering one technical question after another for all that time!"

**PEATS for PARTS**  
**ELECTRONIC COMPONENTS**  
**RADIO & TELEVISION**  
*For the convenience of Irish enthusiasts we supply:*

Radio & Electronics  
 Constructor Data Books  
 Panel Signs  
 Transfers

*Also a postal service*

**PEATS**  
 the world of electronics  
 25 Parnell Street, Dublin 1, Telephone 749972

## MORSE IMPROVEMENT

C90 Cassettes (A) 1-12 w.p.m. with simple exercises. Suitable for R.A.E. preparation. (B) 12-24 w.p.m. computer produced professional level operator material including international symbols.

Price each: complete with instruction and exercise booklets £4.75 including postage.

Morse Key and Buzzer Unit suitable for sending practice and DIY tape preparation.

Price £4.75 including postage  
 Overseas Airmail £1.50 extra.

**MHEL ELECTRONICS (Dept. R)**  
 12 Longshore Way, Milton,  
 Portsmouth (UK), PO4 8LS

## GAREX

V.H.F. Receivers SR-9 for 2-metres F.M., fully tunable 144-146MHz, 2-speed slow-motion dial, also 11 xtal controlled channels. Compact, sensitive, ideal for fixed or mobile listening. Built-in L.S., 12v D.C. operation £47.15 inc. VAT. Crystals, if required: £2.60 each. All popular 2m. channels in stock. Marine band version (156-162MHz) £47.15 (xtals £2.90). Mains psu for above £11.95. Pocket VHF Receiver 12 channel xtal controlled complete with nicad and charger. 4MHz bandwidth in range 140-175MHz £57.95. Amateur and Marine xtals in stock, prices as SR-9.

Amplifier module new, fully assembled 6W IC unit, 12v D.C. Low impedance (4-8  $\Omega$ ) input and output for extn. speaker amplification, with circuit £2.75.

Neons min wire end 70p/10; £4.50/100

Slide switches min DPDT 20p ea; 5+; 16p

Resistor Kits E12 series, 22  $\Omega$  to 1M  $\Omega$

57 values, 5% carbon film,  $\frac{1}{4}$ W or  $\frac{1}{2}$ W Starter

pack, 5 each, value (285) £3.10

Mixed pack, 5 each  $\frac{1}{4}$ W +  $\frac{1}{2}$ W (570) £5.55

Standard pack, 10 each (570) £5.55

Giant pack, 25 each (1,425) £13.60

BNC Cable mtg socket 50  $\Omega$  25p;

5+; 20p; PL259 UHF Plug & Reducer 75p;

5+; 67p; SO239 UHF Socket panel mtd.

60p; 5+; 50p; Nicad rechargeables

physically equiv. to zinc-carbon types: AAA

(U16) £1.80; AA(U7) £1.30; C(U11) £3.35;

PP3 £5.55. Any 5+; less 10%. Any 10+ less

20

We stock V.H.F. & U.H.F. mobile aeri-  
 s.a.e. details.

Access  $\rightarrow$  Barclaycard

PRICES INCLUDE UK POST, PACKING & VAT

Mail order only Sole Address:

GAREX ELECTRONICS

7 NORVIC ROAD, MARSWORTH.

TRING, HERTS HP23 4LS

Cheddington (STD 0296) 668684

a 100  $\Omega$  5% resistor. Because it's a 5% resistor its actual value will be between 105  $\Omega$  and 95  $\Omega$  and it would be perfectly correct to use it in a position calling for 100  $\Omega$  10%, because its value *must* lie between the 90  $\Omega$  and 110  $\Omega$  limits that the circuit it's to be used in requires." (Fig.1.)

"Which, of course," broke in Dick, "applies to any value other than 100  $\Omega$ . It's always safe to employ a resistor with a closer tolerance than that called for."

"Provided we're talking in terms of 10% and 5%," qualified Smithy. "You can also buy resistors with tolerances of 2% and 1%, but it would in general be rather inadvisable to use them in 10% or 5% positions despite the fact that their resistance values will fall within correct limits. The use of 2% and 1% resistors is to be avoided here simply because they are usually a lot more expensive than 10% or 5% resistors, and because they are often much larger in physical size so that they will not fit properly into the layout. What has happened over recent years is that most small resistors on the amateur component market are sold with tolerances of 5% up to 1M  $\Omega$  and with tolerances of 10% above 1M  $\Omega$ . This makes life very easy for the amateur constructor because, so far as values of 1M  $\Omega$  and below are concerned, he simply uses 5% resistors in all positions where 5% or 10% are called for."

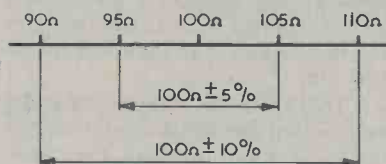

**Fig.1. It is always in order to employ a 5% resistor where a 10% resistor is specified. For instance, a 100  $\Omega$  10% resistor has outside limits of 90  $\Omega$  and 110  $\Omega$ . The actual values in the 100  $\Omega$  5% range fall well within these limits**

"What about the closer tolerance resistors?"

"Resistors with tolerances of 2% and 1%," replied Smithy, "normally appear in specialised projects such as test equipment. With the result that you *have* to obtain the more expensive close tolerance resistors on the few occasions when they are specified."

## WATTAGE

"Well, I think I got that message over to my nephew last night," said Dick. "Then, after that, he started going on about resistor wattage values."

"Which," stated Smithy, "is the second basic requirement of a resistor. In most instances, a resistor in a circuit will have a voltage across it and a current flowing through it, and I hardly need to tell you that voltage multiplied by current is equal to power. The power in a resistor is converted directly into heat. We can see this direct conversion of electrical power to heat in an electric fire bar. The mains voltage is applied across the bar, a current flows through it, and the resultant power causes the bar to go red-hot. If the mains voltage were 250 volts and the current flowing in the bar were 4 amps, the power dissipated as heat by the bar would be 250 times 4, or 1,000 watts."

"In other words, 1 kilowatt."

"That's right. The powers dissipated in resistors in electronics are very much smaller, of course, than those in electric fires, but the electric fire example does show that any electrical power dissipated in a resistor becomes converted directly to heat, and only heat. Now, we obviously don't want a resistor to get too hot, or its value might shift or it could even burn out. So we give the resistor a wattage rating. With a  $\frac{1}{4}$  watt resistor the maximum power that may be safely dissipated before the resistor can become damaged due to heat is  $\frac{1}{4}$  watt. A  $\frac{1}{2}$  watt resistor can dissipate powers up to  $\frac{1}{2}$  watt and a 1 watt resistor can dissipate powers up to 1 watt. Speaking in general terms, and assuming that all the resistors are of the same type, a  $\frac{1}{2}$  watt resistor is made physically larger than a  $\frac{1}{4}$  watt resistor, and a 1 watt resistor is made physically larger than a  $\frac{1}{2}$  watt resistor. Increasing the size of a resistor increases the surface area by which any heat produced in it may be lost due to radiation and convection in the air around it." (Fig.2.)

"Which is, of course, sensible enough."

"Right," said Smithy briskly. "It follows from this, that, if a constructional project specifies a  $\frac{1}{4}$  watt resistor for any position, it is always in order to use a resistor having a slightly higher wattage such as  $\frac{1}{2}$  watt, provided that the higher wattage resistor is not too large to fit into the layout. There are a lot of  $\frac{1}{4}$  watt resistors knocking around



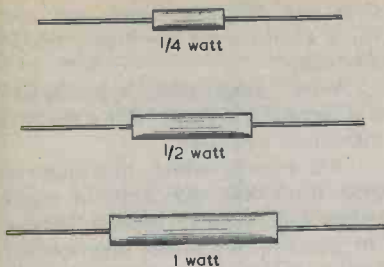

Fig.2. In general, a  $\frac{1}{4}$  watt resistor is larger than a  $\frac{1}{2}$  watt resistor, and a 1 watt resistor is larger than a  $\frac{1}{2}$  watt resistor

these days, and these can also be used where  $\frac{1}{4}$  watt resistors are specified. On the other hand you should never fit a resistor having a lower wattage than that specified, because it is liable to cook up due to the fact that it may dissipate more heat than it was designed for."

"In lots of circuits," said Dick "resistors must be dissipating much less than even a quarter of a watt."

"That's very true," agreed Smithy. "But  $\frac{1}{4}$  watt resistors are normally still called up because these are the smallest generally available low-cost size. A word of warning is required here, incidentally, for the amateur who is *designing* his own circuits. Many of the wattage ratings quoted for resistors in the home constructor market really *are* maximum safe ratings. If you design a circuit and find that the calculated dissipation in a resistor is, say, 0.4 watt you *could* employ a  $\frac{1}{2}$  watt component. But, since the resistor could then possibly be running close to its maximum safe wattage rating, it would be much wiser to play safe and employ a 1 watt resistor."

"You said just now," said Dick, "that the third basic requirement of a resistor is its size."

"Which is very true. Normally, you don't want to employ a resistor which is too big in size or it may not fit into the physical layout of the circuit. I've already mentioned the size factor with regard to close tolerance resistors and resistors having a wattage rating which is larger than that specified. Other resistors which can be too large are old-fashioned types which may turn up in surplus offers and things like that. Modern resistors are quite small and their sizes are quoted in most of the catalogues."

### CATALOGUES

"Catalogues?"

"Yes, catalogues," repeated Smithy. "Unless he has the good

fortune to live near a really good component shop, anybody starting up in radio and electronics should get himself at least two or three of the catalogues of mail-order suppliers. In many instances, mail-order is the only way in which good quality components can be obtained, and it takes hardly any time at all to fill in an order form and post it off with a cheque."

"Cheque?"

"Dash it all, Dick," said Smithy irritably. "Do you have to repeat everything I say? Hasn't your nephew Septimus got a bank account?"

Dick looked at him incredulously.

"Ye gods, Smithy, he's only 12"

"Oh."

Smithy's annoyance vanished and his face broke into a grin.

"Dear, oh dear," he chuckled. "I've been sending off cheques to electronic mail-order houses for so long now that I'd forgotten that any other way existed. Your nephew will probably be able to send crossed postal orders then, or prevail on someone like you to write out cheques for him."

A glint appeared in Dick's eyes.

"Advice I don't mind too much," he said firmly, "but cheques never!"

"All right, all right," said Smithy hastily. "Money is a problem with any hobby, although you can often spend quite a small amount of money for quite complex electronic items. When transistors first appeared they were over a pound each. After all the years of inflation which have passed since then, you can now get a quad 2-input CMOS NAND gate for about 14 pence only."

"Fortunately my nephew hasn't got himself interested in CMOS yet," said Dick. "What he got on to after asking questions about resistors were questions about electrolytic condensers."

"You mean electrolytic capacitors."

"He calls them condensers," said Dick aggrievedly. "Until last night, the main advice he's had has been from his great-uncle Aaron, who used to make crystal sets back in the 20's."

"Great-uncle Aaron," breathed Smithy. "Dear me Dick, what a very peculiar family you have."

"Lots of families are peculiar," stated Dick defensively, "if you dig into them deep enough."

"Well, I wouldn't dispute that," replied Smithy. "'Condenser' is, of course, the old word for 'capacitor', and they both mean precisely the same thing."

## THE MODERN BOOK CO.

Largest selection of English & American radio and technical books in the country

19-21 PRAED STREET  
LONDON W2 1NP  
Tel: 01-402 9176

### SAVE MONEY!

\*\*\* NOW ON \*\*\*  
CASSETTE TAPES

ACADEMY C60 - Super-Low Noise/Hi-output. Cassette Tapes (Ferric Oxide) 2 x 30 mins. Recording/Playing time - 5 for £3.00 P&P included

A.T.Z. C60 - 'Chromium Dioxide' very Low Noise/Hi-output. Cassette Tapes of high quality 2 x 30 mins. Recording/Playing time 5 for £5.00 P&P included

Buy now at lower than pre-Budget prices

SIGTRONIC ELECTRONICS  
27 Malvern Street, Stapehill  
Burton-on-Trent, Staffs. DE15 9DY

## MORSE MADE EASY



BY THE G3HSC  
RHYTHM METHOD!

These courses which have been sold for over 25 years, have been proved many times to be the fastest method of learning Morse. You start right away by learning the sounds of the various letters, numbers, etc., as you will in fact use them. Not a series of dots and dashes which later you will have to transklate into letters and words.

Using scientifically prepared 3 speed records you automatically learn to recognise the code, RHYTHM without translating. You can't help it. It's as easy as learning a tune 18 WPM in 4 weeks guaranteed. The Complete Course consists of three records as well as instruction books. For Complete Course send £5.50 (overseas mail £3.50 extra).

### THE G3HSC MORSE CENTRE

S. Bennett, (Box 8), 45 Green Lane,  
Purley, Surrey.

Name .....

Address .....

"It's a funny sort of word," remarked Dick. "I wonder how it originated."

"Probably from the old Leyden jars," replied Smithy. "These were the first capacitors to see the light of day and in the early days of electricity people used to charge them up to high static voltages and get sparks from them. They used to say that electricity was 'condensed' into the jars." (Fig.3.)

"Oh well," said Dick cheerfully, "you learn something new every day, I always say. Anyway, young Septimus started asking me about working voltage ratings for electrolytic condensers. I mean capacitors."

Smithy paused for a few moments as he marshalled his thoughts.

"The most commonly employed electrolytic capacitor," he said slowly, "is the aluminium type. In this, one plate is a film of aluminium, and it is in contact with an electrolyte. When a direct polarising voltage is applied between the aluminium and the electrolyte a very thin oxide layer appears over the surface of the aluminium. This oxide layer is the dielectric and, because it is very thin, it allows very high values of capacitance to be given over relatively small areas of aluminium. Modern aluminium electrolytics use etched aluminium. This has a greater surface area and allows even larger capacitance to be given. Which all explains the basic reason for the polarising voltage. Now let's get down to this working voltage business."

## WORKING VOLTAGE

"Ah yes," said Dick. "Well, what my nephew wanted to know was this. If a design specifies an electrolytic capacitor with a working voltage of, say, 10 volts

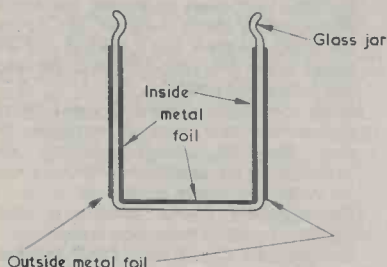

Fig.3. The Leyden jar was a very early fixed capacitor. Connections were made to a metal foil fixed to the inside surface of the jar and to another metal foil fixed to the outside surface. The glass formed the dielectric

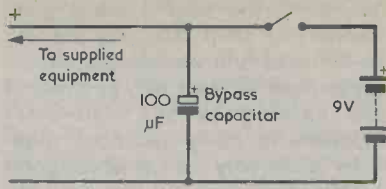

Fig.4. A 100µF bypass electrolytic capacitor connected across 9 volt supply rails. A good choice of working voltage for the capacitor would be 10 volts, but it would be quite in order to use a capacitor with a higher working voltage

does the capacitor *have* to have that working voltage?"

"And the direct answer is that it doesn't," replied Smithy. "It is quite in order to use an electrolytic capacitor having a higher working voltage than that specified, but you should not use a capacitor having a lower working voltage than the specified figure. Precisely what the term 'working voltage' means can vary between different capacitor manufacturers, but the amateur constructor need not worry his head here. All he needs to follow is the rule that the direct voltage applied to an electrolytic capacitor should not exceed its working voltage figure."

"Say you have a circuit which is powered by a 9 volt battery," said Dick, "and you want to connect a 100µF electrolytic bypass capacitor across the supply rails. The best choice would be a 100µF 10 volt working capacitor, wouldn't it?"

"It would," agreed Smithy, "but if you couldn't get a 100µF capacitor in 10 volts working, there would be no harm done if you used a 100µF capacitor which had a working voltage of 16, 25 or even 40 volts. All these capacitors would function perfectly well and they would all have an adequate polarising voltage. The only snag is that the size of an electrolytic capacitor increases with working voltage and components with a much higher working voltage may be too large to fit into the equipment being made. With electrolytics having values below 10µF you are often forced to use capacitors having high working voltages because components with lower working voltages simply aren't available. With a 1µF capacitor, for instance, you may have to use a component with a working voltage as high as 63 volts where only 10 volts working is required. This is all right electrically and there are normally no problems

over size because these very low value electrolytics are pretty tiny in any case."

"Why," asked Dick, "do they call it a 'working voltage' if it's really a maximum voltage?"

"It's a term which has lingered over from the old days of valve radios and TV sets," replied Smithy. "In those times, most electrolytics had a maximum working voltage rating and a maximum surge voltage rating which was higher. Imagine that you had a mains radio with an electrolytic reservoir capacitor and an electrolytic smoothing capacitor. Immediately after switching on the receiver, the h.t. rectifier would produce a rectified h.t. voltage but, because the valves in the set hadn't yet warmed up, they would draw no h.t. current. In consequence, the h.t. voltage would be considerably higher than its normal value until the valves started passing current. This high voltage would need to be lower than the surge voltage rating for the two electrolytics and the lower voltage after the valves had warmed up would need to be below the maximum working voltage rating of the electrolytics. Just to show you the dangers we service engineers used to work with in those days, it was common practice to design electrolytics whose leakage current increased considerably above the maximum working voltage, and this increased leakage current kept the rectified surge voltage lower than it otherwise would be!" (Fig.5.)

"Blimey," said Dick. "Using electrolytics like zener diodes!"

"True," laughed Smithy. "But the surge voltage rating has now disappeared, and we refer, so far as amateur applications are concerned, to a working voltage which can be looked upon simply as a maximum voltage."

"My nephew," said Dick, "also started on about value tolerances in electrolytics."

"For a 12 year old," stated Smithy, "that nephew of yours seems to be showing remarkable promise. It is, of course, a well known fact that aluminium electrolytics have a wide tolerance on value, this being normally about 10% to +50%. There is another type of electrolytic, this being the tantalum type. These are small capacitors which exhibit a very low leakage current, but they aren't used very often in amateur projects. Whenever an electrolytic capacitor is called for in a published design you can always assume that it's an aluminium type unless the article



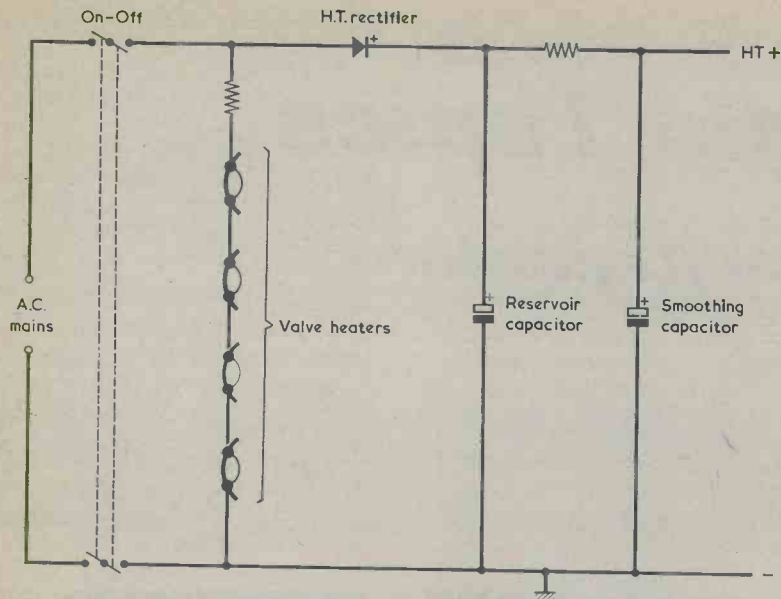
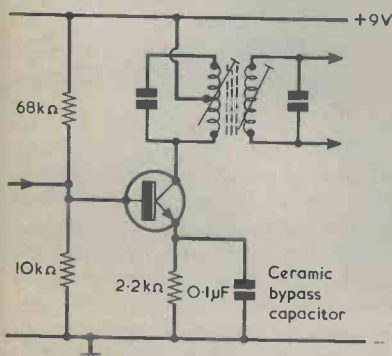

**Fig.5. Power supply arrangements in valve radios meant that a high surge voltage appeared across the electrolytic capacitors after switch-on until the valves warmed up and drew h.t. current**

specifically states otherwise. Your nephew will also find a wide tolerance on value in another type of capacitor, the low voltage disc ceramic. These have fairly high capacitances, for their size, of  $0.01\mu\text{F}$  up to  $0.47\mu\text{F}$  or so, and the tolerances on value are something like -25% to +50%. This particular type of non-electrolytic capacitor also has quite a low leakage resistance, it being in the region of megohms or even less. They're used in applications where this low leakage resistance doesn't upset circuit operation." (Fig.6)

"What about tolerances in general with non-electrolytic capacitors?"

"Normally, the tolerances on value are about 10% or 20%. Funnily enough, it so happens that in most electronic applications it doesn't matter that non-electrolytic



**Fig.6. Some disc ceramic capacitors have low leakage resistances, in the order of megohms. This low leakage resistance would have no effect if such a capacitor were used as an emitter bypass capacitor in this typical i.f. amplifier stage**

capacitors have these fairly wide tolerances. Whilst a circuit may require resistors with a tolerance of 5%, it can work satisfactorily with capacitors having tolerances of 20%. That's just one of those things that you get used to."

"Capacitors in tuned circuits need to have close tolerances though, don't they?"

"Ah yes," conceded Smithy. "A capacitor in a tuned circuit may be specified as having a tolerance as close as 1% on value. Almost inevitably, such capacitors will be specified as silvered mica or polystyrene foil, and these two types are readily available in 1%."

"Well," said Dick, "all this goes over pretty well the same ground as I covered with young Septimus last night. Gosh, did he ask questions? I thought he'd never stop!"

"Very trying for you," remarked Smithy drily. "Has he made up any circuit's yet?"

"Not on his own," replied Dick. "They've got a little electronics club at his school which is run by one of the masters, and he's helped in making a few gadgets there. But he now wants to start making his own projects at home."

"Make sure he gets a good soldering iron, then," said Smithy immediately. "There are a few junky no-name soldering irons knocking around in some hardware shops which are quite useless. A good iron is normally sold in a proper carton complete with its manufacturer's name, and it will usually be a type having replacement bits. Its rating should be of the order of 20 watts.

If in doubt, buy a soldering iron which is featured in a mail-order electronic components catalogue. And tell your nephew to be sure to use 60/40 tin-lead solder or Multicore 'Savbit'. A lot of the solder which is sold in hardware shops is the cheaper 40/60 alloy. This is all right for electrical joints but it's hopeless for fine electronic work."

"Anything else he should have?"

"A multimeter is very helpful," said Smithy. "It doesn't have to be extremely accurate for simple work and a cheap imported one will do for starters. Because they're low cost, such testmeters are a bit more fragile than the more expensive ones, but this only means that they have to be looked after more carefully. Preferably the testmeter should have a resistance of  $10,000\Omega$  per volt or more on its voltage ranges, but it's still possible to get fairly useful results with a multimeter which is as low as  $1,000\Omega$  per volt, and such a meter can be attractive if it's available at a low cost. The situation is rather sad here, particularly for youngsters, because four or five years ago there were stacks of really inexpensive imported meters knocking around, but most of these have disappeared from the scene at the time being. The thing to do here is to keep an eye open for bargains when the money supply is limited."

## END OF BREAK

Smithy glanced at his watch and then drained his tin mug.

"I've just thought of something," said Smithy.

"What's that?"

"The sooner this nephew of yours gets really genned up the better it will be for you."

"How come?"

"Well, he'll be able to do all the little electrical jobs for your family which you've been doing up to now!"

Dick looked at him admiringly.

"Hey, that's a really bright idea. From now on, all the advice he gets will be to my own ultimate benefit. Gosh Smithy, you aren't half crafty!"

Smithy grinned modestly.

"Tell you what," continued Dick enthusiastically. "I can speed things up by bringing him round to you. You could give him information much better than I can!"

Smithy blanched at the prospect.

What is the old saying about foot-in-mouth disease?

# Radio Topics

## By Recorder



As a late convert to the pocket calculator I find that these delightful little machines can provide quite a lot of relaxation after a heavy day of dreaming up electronic schemes or scheming how to use other people's electronic dreams.

When last I wrote about number doodling with a calculator I suggested that you key in any digit from 1 to 9 inclusive, then multiply it successively by 3, 7, 11, 13 and 37. After this press the "equals" button, whereupon you should get the original digit repeated six times along the display.

### SIMPLE DOODLES

Here's another simple exercise. Key in any digit from 1 to 9 inclusive then multiply it first by 101 and then by 11. Press the "equals" button, and the digit repeats four times along the display. Multiply next by 73 and then by 137, and again press the "equals" button. The four digits will now be expanded to eight digits.

All this is elementary stuff, of course, as the exercise is simply employing the factors of 1111 (101 multiplied by 11) and 10001 (73 multiplied by 137). The four factors are all prime numbers and it is of mild interest to see how high some of them are.

Another little matter I have stumbled upon by doodling with a calculator has to do with palindromic numbers. These are numbers which read the same both ways. For a start, punch in 4004, which is a palindromic number having four digits. Then divide it by 11. The answer is a whole number, without any decimals. Try it with any other palindromic number having four digits and you will find that this, too, is directly divisible by 11.

Repeat the exercise with palin-

dromic numbers having six digits and, again, you'll find that these are all directly divisible by 11. Then check with palindromic numbers having eight digits. If your calculator can cope with these you will yet again find that the numbers can be directly divided by 11. A palindromic number having ten or twelve digits is also directly divisible by 11, but you will have to do these divisions the old-fashioned way.

Which brings me to my soon-to-be-famous Recorder's Hypothesis. The Hypothesis states that *any* palindromic decimal whole number having an even number of digits is directly divisible by 11.

This must be old hat to the mathematicians, but it's nice to make a claim for fame even if it is

only short-lived. Or until someone disproves the hypothesis.

### DOT MATRIX PRINTER

One approach towards obtaining a computer printout is shown in the accompanying photograph, in which the readout characters are being reproduced on electro-sensitive paper in the form of a dot matrix. The unit illustrated is the Olivetti NIP18, this being a serial printer capable of producing up to 50 characters per second.

The basic printer uses a 7-electrode moving print head and is capable of printing numerals, letters, commercial symbols and scientific symbols at up to 25



The Olivetti NIP18 dot matrix printer incorporated in a microprocessor control system. The printer will operate in a wide range of ambient temperature and humidity, and it functions in any plane



characters per line. The head mechanism itself is designed for printed circuit board mounting; it weighs only 190 grams and measures 175 by 80 by 45mm. overall.

The character height is relatively large at 3mm., and character width is variable. The average print head life is in excess of 2 million operations, a factor which should make the unit particularly attractive to manufacturers of portable instruments, processing equipment, data loggers and mobile data terminals. A further advantage is that the printer will operate in any plane, at temperatures between -20°C and +50°C, and in conditions where relative humidity can be as high as 90%.

The NIP18 printer is being offered by Impectron Ltd., as a basic printer module or in an "OEM" package. This option includes a printed circuit board on which the basic printer is mounted, the board also carrying a pre-tested circuit for BCD/ASCII character generation, together with all control and drive circuits necessary to drive the printer, and mechanical accessories such as paper holder and tear-off strip. The package offers its users the ability to connect up and use the printer without additional components or control circuitry.

A further package, in which the printer is supplied with a microprocessor controlled drive circuit, allows a far more flexible approach to be made. With this second option a wide range of alphanumeric characters and symbols may be printed, with six possible print sequences. Characters may be printed from left to right, right to left, with each sequential line above or below its predecessor, or even upside-down. Since all characters in any one line are stored in the 24-character memory before printing, the final print copy appears in the correct, readable sequence.

The print sequence choices are particularly of value in such applications as scientific instruments, which may output the most significant digit as the first or last digit, in point-of-scale equipment where the top or bottom line may each represent the total, or in tickets and receipts where the upside-down facility makes the characters readable from either end.

The assembly may be connected directly to any ASCII/BCD input alpha-numeric display, allowing a visual image to be made of characters stored in the line memory. This enables corrections or

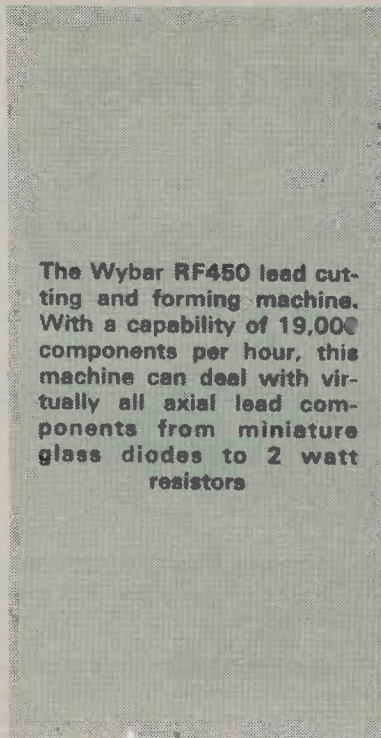

**The Wybar RF450 lead cutting and forming machine. With a capability of 19,000 components per hour, this machine can deal with virtually all axial lead components from miniature glass diodes to 2 watt resistors**

amendments to be made before printing, and is particularly useful where the printer is connected to a keyboard as in data communications terminals.

Further details on the basic printer and the ancillary packages may be obtained from Impectron Ltd., Impectron House, 23-31 King Street, London, W3 9LH. (And, to clear up one of those irritating unexplained acronyms which flourish in the world of microprocessors, ASCII stands for American Standard Code for Information Interchange).

## COMPONENT LEAD FORMING

What goes on in electronics factories is always of interest. Manufacturers would, for instance, soon be running up their costs if the lead-outs of all the resistors, capacitors and diodes fitted to their printed circuit boards were cut and bent by hand. Repetition work of this nature has to be carried out by machines, and the second photograph illustrates a newly available machine which is specifically intended for dealing with the wires of axial lead components. This is the Wybar model RF450, marketed by Eraser International Ltd., 2/3 Hampton Court Parade, East Molesey, Surrey, KT8 9HB.

The RF450 is a compact, bench mounted, electrically operated machine which will process electronic components regardless of whether they are supplied or banded on reels, on cards or simply loose.

The machine is adjustable for different component configurations and the accuracy of fixed cutting and forming dies is achieved without the high cost such dies would otherwise involve. All cutting dies are manufactured from the highest grade of tungsten carbide and provide twelve cutting edges which may be position indexed as required. The forming dies are chrome plated to prevent tin build-up and are fully reversible in case any wear should occur. The forming edges on the bending dies are radiused to prevent any risk of nicking outs. Special "Delfin" forming dies can be supplied for applications where there must be no marking whatsoever.

The production rate of the RF450 is 19,000 components per hour, and this is given for components ranging from the smallest glass diode to resistors with ratings of 2 watts. The unit is powered by a standard 240 volt 50Hz gear motor which is sealed for life, and no routine maintenance is required.

# New Products

## DIGITAL THERMOMETERS

For over half a century, Avo Ltd. have been manufacturing measuring instruments, with special emphasis on multimeters. Currently the company supplies both digital and analogue types of multimeter, wellknown in the electrical and electronic industries for their accuracy and reliability. They measure the three most important electrical quantities, voltage, current and resistance, and are suitable for a wide range of applications.

Another very important parameter in almost all industrial and processing environments is temperature. Chemical processing, food processing, electronic engineering, medicine, drug manufacture, design and development laboratories are only a few of the fields in which temperature is important and sometimes critical.

Avo are entering this area of measurement with the introduction of two new digital thermometers, the AT1 and the AT2. Both thermometers are designed for use with thermocouple sensors type K (NiCr/NiAl) and are accurate and easy to use.

The AT1 Digital Thermometer is a battery operated, portable unit with a liquid crystal display. The 9V transistor battery provides power for up to 6 months, so that temperature checks can be made without the need to be near a mains supply.

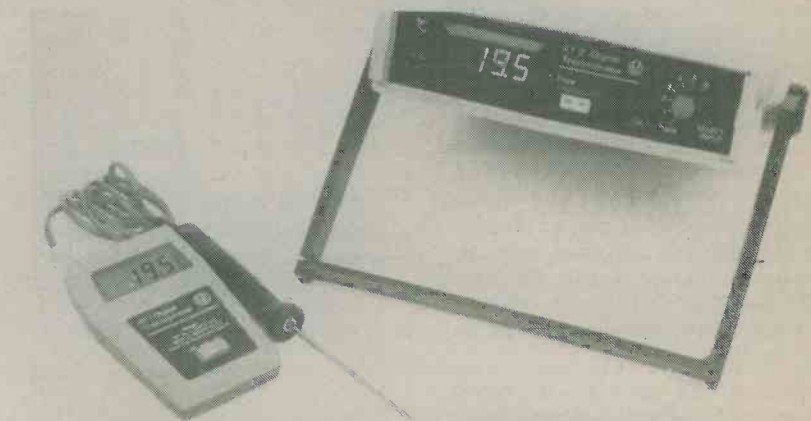

Digital Thermometer Models AT1 (hand held) and AT2 (bench/portable) are spearheading Avo's entry into the temperature measurement market

The thermometer covers a temperature range of  $-65^{\circ}\text{C}$  to  $+1150^{\circ}\text{C}$  to an accuracy of  $\pm 0.2\%$   $\pm 1$  digit. The moulded, shockproof case is designed to give a wide viewing angle for the display.

The AT2 Bench Digital Thermometer is equally suitable for field or laboratory use, as power is supplied from either an internal rechargeable battery or the mains supply. The 14 mm light emitting diode display gives a large, bright reading of the temperature.

The instrument covers a temperature range of  $-65^{\circ}\text{C}$  to  $+1200^{\circ}\text{C}$  to an accuracy of  $\pm 0.2\%$  of reading  $\pm 0.5^{\circ}\text{C}$ . Up to six ther-

mocouples may be connected to the rear panel and a compatible plug is provided on the front panel. A rotary switch selects any one of the seven inputs, so that the thermocouples, simultaneously detecting different temperatures, can be permanently wired to the AT2.

The instrument is housed in a rugged case with a tilt stand, which can also be used as a carrying handle.

The AT1 and AT2 digital thermometers, and the five types of thermocouple probe are available from appointed Avo Distributors in the U.K. and throughout the world.

## LOW-COST OSCILLOSCOPE PROBES

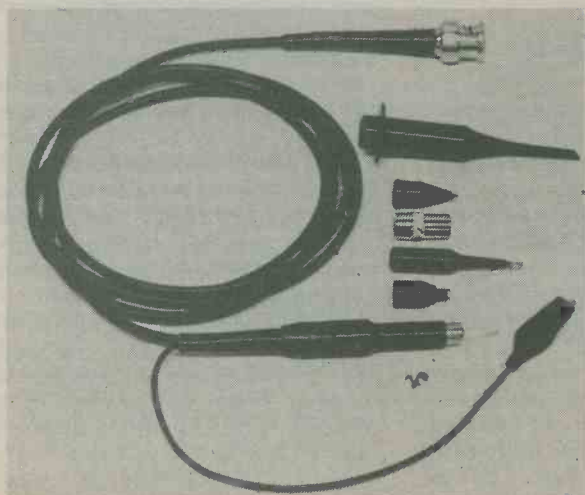

Photograph shows Electronic Brokers Ltd new range of low-cost probes, designed for use with all popular makes of oscilloscopes

Electronic Brokers Ltd., of 49/53 Pancras Road, London NW1 2QB, is launching a new range of low-cost probes, designed for use with all popular makes of oscilloscopes.

The probes are available in two alternate kit forms — model XI or X10 and model X1X10 is a switched probe. Each is supplied with a set of accessories, including a sprung hook tip, IC Tip, BNC adaptor and a trimmer tool. Model X10 has a bandwidth of 100 MHz and the X1 a bandwidth of 20 MHz. Maximum working voltage is 600 v DC, including peak AC.

All three probes have a cable length of 1.5 metres and are supplied in an attractive zip-up plastic wallet.

Prices start from £9 a kit, with discounts offered for quantities.



# SMALL ADVERTISEMENTS

Rate: 12p per word. Minimum charge £2.00

Box No. 30p extra

Advertisements must be prepaid and all copy must be received by the 4th of the month for insertion in the following month's issue. The Publishers cannot be held liable in any way for printing errors or omissions, nor can they accept responsibility for the *bona fides* of Advertisers. Where advertisements offer any equipment of a transmitting nature, readers are reminded that a licence is normally required. (Replies to Box Numbers should be addressed to: Box No. —, *Radio and Electronics Constructor*, 57 Maida Vale, London, W9 1SN.

**200 MIXED COMPONENTS** £3.50. Money refunded if not satisfied. Send S.A.E. for list of our other bargain packs. Servio Radio, Dept. RE1, 156-158 Merton Road, Wimbledon, London SW19 1EG.

**COMPLETE REPAIR INSTRUCTIONS** for any requested TV, £5 (with diagrams £5.50). Any requested service sheet £1 plus s.a.e. S.a.e. brings free newsletter, details unique publications, vouchers and service sheets from 50p. AUSREC, 76 Church Street, Larkhall, Lanarkshire.

**THE "MARGROVE" V.H.F. (40-180MHz) TUNER KIT.** Ultra sensitive 2/transistor design. Includes: fibre-glass p.c.b., all hardware, inductors, transistors (f.e.t.'s), easy-build instructions, resistors, etc. — only £5.95 post paid. Note: this quality kit contains everything except the capacitors, i.e. 10pF variable & 8 easily obtained fixed types. Descriptive literature — s.a.e. M. J. Evans, 7 Shap Drive, Warndon, Worcester. Mail order only.

**FOR SALE:** Inverter, 12V d.c. to 240V a.c. Suitable running electric shaver, camping, boating, etc. £5.50. Box No. G355.

**METAL DETECTORS** £6.90. 100 Mixed components £2.50. Lists 15p. Sole Electronics (REC), 37 Stanley Street, Ormskirk, Lancs., L39 2DH.

**FOR SALE:** *Fundamentals of Radio Servicing* by B. W. Hicks, published by Hutchinsons Educational, £2.20 post paid. *Handbook of Satellites and Space Vehicles* by R. P. Haviland, £3.50 post paid. — Box No. G366.

**THE RADIO AMATEUR INVALID & BEDFAST CLUB** is a well established Society providing facilities for the physically handicapped to enjoy the hobby of Amateur Radio. Please become a supporter of this worthy cause. Details from the Hon. Secretary, Mr. H. R. Boutle, 14 Queens Drive, Bedford.

(Continued on page 445)

## BUILD YOUR OWN

**P.A., GROUP & DISCO SPEAKERS** by R. F. C. Stephens

Save money with this practical guide. Plans for 17 different designs. Line source, I.B., Horn and Reflex types, for 8"-18" drive units. £3.95 post free (\$8 overseas).

**THE INFRA-BASS LOUDSPEAKER** by G. Holliman

(full constructional details for versions using 15", 12" and 10" drive units.) £2.95 post free (\$6 overseas).

**THE DALESFORD SPEAKER BOOK** by R. F. C. Stephens

This book is a must for the keen home constructor. Latest technology DIY designs. Plans for I.B., and Reflex designs for 10-100 watts. Also unusual centre-bass system. £2.20 post free (\$5 overseas).

VAN KAREN PUBLISHING  
5 Swan Street, Wilmslow, Cheshire

# MARCO TRADING

To obtain a free copy of our 35 page list simply send a 20p postage stamp or a large SAE. This advertisement shows only a part of our range. (Our new list includes Tants, Electrolytics, Disc ceramics, etc.)

## 400m/w ZENER DIODES Low Price

3V6, 3V9, 4V3, 4V7, 5V1, 5V6, 6V2, 6V8, 7V5, BV2, 9V1, 10V, 11V, 12V, 13V, 13V5, 15V, 16V, 18V, 20V, 22V, 24V, 27V, 30V, 33V.  
Price: 8p each 100 any mix £8.00

## 1 watt ZENER DIODES

3V3 to 200V Full range  
Price: 15p each 100 any mix £12.50

8 DIL	10p
14 DIL	13p
16 DIL	15p
18 DIL	18p
20 DIL	22p
22 DIL	23p
24 DIL	24p
28 DIL	28p
40 DIL	40p

## VEROBOARD (Copper Clad)

Size Inch	0-1"	0.15
2.5 x 1	20p	N/A
2.5 x 5	55p	56p
2.5 x 3.75	46p	50p

Vero Wiring Pen (including spool of wire) £2.84

## CONNECTING CABLE

Black, Blue, Green, Grey, Orange, Pink, Red, White, Violet, Yellow, Brown.  
Singles 5p per metre  
7/0.2mm 5p per metre  
16/0.2mm 8p per metre

## BRIDGE RECTIFIERS

400V	32p
800V	43p
2.0Amp 50V	58p
100V	35p
400V	42p
6.0Amp 50V	50p
200V	70p
400V	78p
	85p

## 0.1W SUB. MINIATURE PRE-SETS

100Ω to 1Meg Vertical or Horizontal  
Price: 6p each. 100 any mix £4.50

## LINEAR IC's

CA3018	67p
CA3035	70p
CA3046	£2.30
CA3048	£2.18
AY10212	£5.80
AY11313	£6.60
AY51224A	£2.50
AY51230	£4.40
AY58100	£5.60

Full range of Panel Meters available £6.25 each

## SPECIAL OFFERS

Power Amplifier Sanyo STK015 Brand New Full Spec etc. 10 Watts into 8Ω.  
Free spec sheet with every order. Our price: £2.50 each.  
Radio Spares Edge Meter Type MR100 (259-562). All new and boxed. RS price over £4.00 each. Our price: £2.50 each.

Send your orders to:

DEPT. DP12, MARCO TRADING, THE OLD SCHOOL, EDSTASTON, Nr. WEM, SHROPSHIRE SY4 5RJ

Tel: Whixall (094872) 464/465

Please add 25p postage and packing to each order and add 15% VAT to your total order. Export add NO VAT but add postage Air/Sea at cost.

# T&J ELECTRONIC COMPONENTS

Quality Components —

Express Service

**Semiconductors:** BC107/8/9 10p; BC182/3/4 10p, 2N3702/3/4/5 8p, BSX20 17p, BF197 12p, OA90/1 7p, 1N4002 6p, BZY88 2V7 to 30V 10p, NE555 25p, 7400 10p, 741 8 pin 21p, ZN414 100p.

**Resistors:** ½ and ¼W 5% E12 from 4.7Ω to 1M, 2p each. 15p/10.

**Potentiometers:** 4.7k, 10k, 22k, 100k, 470k, 1M Log or Lin 29p.

**Miniature presets:** 100Ω to 1M. Horz or vert 7p.

**Opto:** 0.125" & 0.2" l.e.d.'s, red 11p, yellow 19p, green 19p, clips either type 2p extra.

**Switches:** Standard toggle s.p.s.t. 33p, d.p.d.t. 43p, rotary 1p. 12W. 2p, 6W 3p, 4W 4p, 3W 40p, rotary mains d.p.s.t. 40p.

**P.C.B. KIT:** Comprehensive kit includes the following: etching dish, ferric chloride, Dalo etch resist pen, drill, 100 sq ins of copper clad board, set of p.c.b. transfers, instructions. £5.25 + 65p p&p. The transfers are available separately at £2.50.

**BIB Hi Fi Accessories.** Ref 61 Cassette index cards, for library containers 40p. Ref 69 anti static cleaner (20cc bottle) 40p.

**Plugs and sockets.** Din plugs 2 pin 7p, 3 pin 11p, 5 pin 13p, phono plugs red or black 10p, 2.5mm jack 11p. Din sockets 2 pin 7p, 3 pin 9p, 5 pin 10p, 2.5mm socket 10p.

**AC-DC adapter.** Provides outputs of 3, 6, 9, 12 volts at up to 300mA. Small size. Suitable for radios, cassettes etc. £3.85.

**Telephone pick-up coil,** suction type with 3.5mm plug 70p.

**Crocodile clips.** Standard 7p, small insulated, red or black 7p.

**Our most popular component pack:** PT3, Five ½W resistor of each value from 10Ω to 1M. £3.25. All other packs previously advertised still available.

We also stock Veroboard, capacitors, all boxes, wire, cable, coil formers, heat-sinks. In fact too much to list here. Send a S.A.E. for our full lists.

Mail order only. All prices include VAT.

Please add 20p for postage. Same day service on all orders.

98 Burrow Road, Chigwell, Essex, 1G7 4HB

# DIRECT SUPPLY SERVICE TO READERS

## TOWERS INTERNATIONAL OPAMP LINEAR-IC SELECTOR

(JUST PUBLISHED)

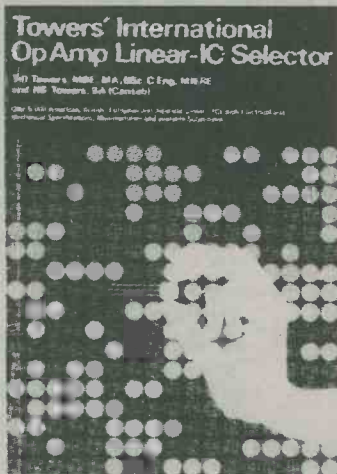

This opamp linear-IC compendium, a comprehensive tabulation of basic specifications for over four thousand opamps, offers information on:

1. Ratings
2. Characteristics
3. Case details
4. Terminal identifications
5. Applications use
6. Manufacturers
7. Substitution equivalents (both European and American)

This work covers not only classical 'pure' opamps, but also several classes of 'quasi-opamps' (i.e. linear-ICs with opamp-like characteristics) such as dc-comparators, operational-transconductance-amplifiers, differential-output amplifiers, current-difference amplifiers, and voltage-follower amplifiers.

The more than 4,000 opamps covered in this self-contained volume are a selection of the more common current and widely-used obsolete types.

The coverage is international in scope and includes opamps not only from the USA and Continental Europe, but also from the United Kingdom and the Far East (Japan).

Price **£7.50** inc P&P

(Please allow 21 days for delivery)

## TOWERS INTERNATIONAL FET SELECTOR

Towers International  
Fet Selector

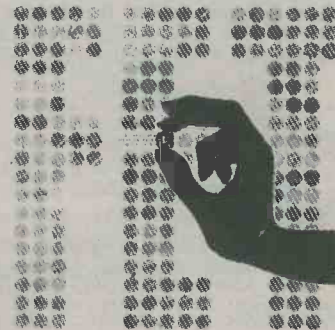

If you deal with field effect transistors, or fet's — whether as a student, a hobbyist, a circuit engineer, a buyer, a teacher or a serviceman — you often want data on a specific fet of which you know only the type number.

Specifications apart, you may be even more interested in where you can get the device in question. And perhaps more important still (particularly with obsolete devices), you may want guidance on a readily available possible substitute.

This fet compendium, a comprehensive tabulation of basic specification offers information on:

1. Ratings
2. Characteristics
3. Case details
4. Terminal identifications
5. Applications use
6. Manufacturers
7. Substitution equivalents (both European and American)

The many fet's covered in this compendium are most of the more common current and widely-used obsolete types.

It is international in scope and covers fet's not only from the USA and Continental Europe, but also from the United Kingdom and the Far East (Japan).

Price **£4.00** inc P&P

**Tower's International OpAmp Linear-IC Selector** by **T. D. Towers**  
MBE, MA, BSc, C Eng, MIERE  
**£7.50**  
inc. post and packing

To:—DATA PUBLICATIONS LTD.  
57 MAIDA VALE  
LONDON W9 1SN

Please send me ..... copy/copies  
to the address shown below

NAME .....

ADDRESS .....

(Block capitals)

**Tower's International FET Selector** by **T. D. TOWERS**  
MBE, MA, BSc, C Eng, MIERE  
**£4.00**  
inc. post and packing

To:—DATA PUBLICATIONS LTD.  
57 MAIDA VALE  
LONDON W9 1SN

Please send me ..... copy/copies  
to the address shown below

NAME .....

ADDRESS .....

(Block capitals)



## SMALL ADVERTISEMENTS

(Continued from page 443)

**FOR SALE:** Heathkit SB 401 Tx, 80-10 metres SSB/CW, 200 watts p.e.p. £100. Shure 444 microphone £15. BC 221 Frequency Meter with power supply and book £25. Sinclair PDM 35 Digital Multimeter in case with leads £30. CR100 with modifications £20. 500V Megger with leather case £5. All are o.n.o. Ed. Hartley, "Byways", Chapel Road, Mutford, Beccles, Suffolk, NR34 7UU.

**FOR SALE:** Bush cassette tape recorder, battery driven. Microphone, etc. Excellent condition. £10 plus postage. Box No. G375.

**INTERESTED IN RTTY?** You should find the "RTTY Journal" of interest. Published in California, U.S.A., it gives a wide outlook on the current RTTY scene; RTTY-DX: DXCC Honour Roll; VHF RTTY news; and up to date technical articles are included. Specimen copies 35p from: The Subscription Manager, RTTY Journal, 21 Romany Road, Oulton Broad, Lowestoft, Suffolk, NR32 3PJ.

**FOR SALE:** "Challenge of the Stars" by Patrick Moore and David A. Hardy £2.00. "Destroyers" by Antony Preston £4.00. Box No. G376.

**INTERESTED IN OSCAR?** Then join AMSAT-UK. Newsletters, OSCAR NEWS Journal, prediction charts, etc. Details of membership from: Ron Broadbent, G3AAJ, 94 Herongate Road, Wanstead Park, London, E12 5EQ.

**CUSTOM ENGRAVED FASCIAS** for your projects in brushed aluminium, bronze, brass and a wide range of colours. Send your requirements. We do the rest. Male, 159 Victoria Road, Swindon, Wilts., SN1 3DA.

**COLLECTORS' ITEMS.** Nearly 50 copies of Radio Society of Great Britain's *Bulletins* covering period 1945 to 1949. In reasonable condition. Offers to: Box No. G377.

**FOR SALE:** Arac 102 receiver 28-30MHz and 144-146MHz. AM-FM-CW-SSB. 12V d.c. Excellent condition. £85.00 o.n.o. G2UK, 21 Romany Road, Oulton Broad, Lowestoft, Suffolk.

**JOIN THE INTERNATIONAL S.W. LEAGUE.** Free services to members including Q.S.L. Bureau, Amateur and Broadcast Translation, Technical and Identification Dept. — both Broadcast and Fixed Stations, DX Certificates, contests and activities for the SWL and transmitting members. Monthly magazine, *Monitor*, containing articles of general interest to Broadcast and Amateur SWLs, Transmitter Section and League affairs, etc. League supplies such as badges, headed notepaper and envelopes, QSL cards, etc., are available at reasonable cost. Send for League particulars. Membership including monthly magazines, etc., £6.00 per annum. (U.K. and British Commonwealth), overseas \$12.00. Secretary ISWL, 1 Grove Road, Lydney, Glos., GL15 5JE.

**WANTED:** Telford Communications TC10 "Multimode" 2 metre transmitter. Details and price please to Box No. G383.

**POSTAL ADVERTISING?** This is the Holborn Service. Mailing lists, addressing, enclosing, wrapping, facsimile letters, automatic typing, copy service, campaign planning, design and artwork, printing and stationery. Please ask for price list. — The Holborn Direct Mail Company, Capacity House, 2-6 Rothsay Street, Tower Bridge Road, London, S.E.1. Telephone: 01-407 6444.

**SHACK CLEARANCE:** Large selection of good quality new components selling cheaply. S.A.E. for lists or enquiries. Box No. G386.

**CONSTRUCT METAL DETECTORS:** 1. £120 pulse discriminator (£12 construction cost). 2. £60 model (£6 con./cost). 3. £30 BFO (£3 con./cost). For all three together, written guaranteed d.i.y. plans, send £2. (Dept. RC), J. Lucas, 2 College Road, Grays, Essex. (Established 1973).

(Continued on page 447)



# Wilmslow Audio

*THE firm for speakers!*

**SEND 30p FOR THE WORLDS BEST CATALOGUE OF SPEAKERS, DRIVE UNITS KITS, CROSSOVERS ETC. AND DISCOUNT PRICE LIST**

AUDAX • AUDIOMASTER • BAKER • BOWERS & WILKINS • CASTLE • CELESTION • CHARTWELL • COLES • DALESFORD • DECCA • EMI • EAGLE • ELAC • FANE • GAUSS • GOODMANS • I.M.F. • ISOPON • JR • JORDAN WATTS • KEF • LEAK • LOWTHER • MCKENZIE • MONITOR AUDIO • PEERLESS • RADFORD • RAM • RICHARD ALLAN • SEAS • STAG • TANNOY • VIDEOTONE • WHARFEDALE • YAMAHA • SHACKMAN • TANGENT

## WILMSLOW AUDIO DEPT REC

SWAN WORKS, BANK SQUARE, WILMSLOW CHESHIRE SK9 1HF

Discount HiFi Etc. at 5 Swan Street

Tel: 0625-529599 for Speakers, 0625-526213 for HiFi



**SOME THINGS YOU CAN DO WITHOUT ... but the HOME RADIO CATALOGUE is Top Priority for every constructor**

- About 2,500 items clearly listed and indexed.
- Profusely illustrated throughout.
- 128 A-4 size pages, bound in full-colour cover.
- Bargain list of unrepeatable offers included free.
- Catalogue contains details of simple Credit Scheme.

HOME RADIO (Components) LTD.  
Dept. RC, P.O. Box 92, 215 London Road, Mitcham, Surrey  
Phone: 01-648 8422

Please write your Name and Address in block capitals

NAME .....

ADDRESS .....



HOME RADIO (Components) LTD., Dept. RC  
P.O. Box 92, 215 London Road, Mitcham, Surrey  
Regd. No. 912966, London

POST THIS COUPON with cheque or P.O. for £1.30

# REVOR OPTICAL & TECHNICAL

6 SICILIAN AVENUE  
LONDON W.C.1  
Tel. 01-836 4536

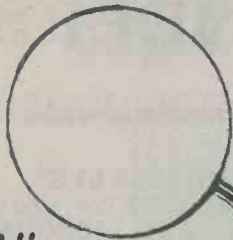

**4"** dia. lens

**£14.91**

**POST  
FREE**

## FLEXIBLE MAGNIFIER

WITH CAST IRON BASE,  
PRECISION GROUND AND  
POLISHED LENS, CHROME PLATED  
FRAME AND FLEXIBLE TUBE.  
IDEAL FOR HOBBIES, AND  
DETAILED WORK WHICH REQUIRES  
BOTH HANDS FREE.

CALLERS WELCOME

(Subject to price ruling at the time of issue)

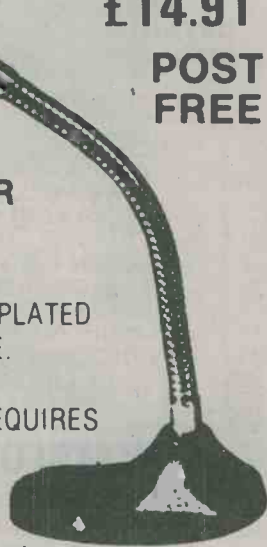

## A CAREER IN RADIO

Start training **today** and make sure you are qualified to take advantage of the many opportunities open to the trained person. ICS can further your technical knowledge and provide the specialist training so essential to success.

ICS, the world's most experienced home study college, has helped thousands of ambitious men to move up into higher paid jobs — they can do the same for **you**.

Fill in the coupon below and find out how!

There is a wide range of courses to choose from, including:

### CITY & GUILDS CERTIFICATES

Telecommunications Technicians'  
Radio TV Electronics Technicians'  
Electrical Installations Technicians'  
Electrical Installation Work  
Radio Amateurs'

MPT Radio Communications Cert

EXAMINATION STUDENTS —

GUARANTEED COACHING

UNTIL SUCCESSFUL

### TECHNICAL TRAINING

ICS offer a wide choice of non-exam courses designed to equip you for a better job in your particular branch of electronics, including:

Electronic Engineering & Maintenance  
Computer Engineering/Programming  
Radio, TV & Audio Engineering & Servicing  
Electrical Engineering Installations & Contracting

### COLOUR TV SERVICING

Technicians trained in TV Servicing are in constant demand. Learn all the techniques you need to service Colour and Mono TV sets through new home study course approved by leading manufacturer.

POST THIS COUPON OR TELEPHONE FOR FREE PROSPECTUS

I am interested in .....

Name ..... Age .....

Address .....

Occupation .....

**ICS**

Accredited  
by CACC  
Member of  
ABCC

To  
International Correspondence Schools  
Dept S278 Intertext House, LONDON  
SW8 4UJ or phone 01-622 9911 (anytime)

# Self-Binder

for "Radio & Electronics  
Constructor"

The "CORDEX" Patent Self-Binding Case will keep your issues in mint condition. Copies can be inserted or removed with the greatest of ease. Rich maroon finish, gold lettering on spine.

Specially constructed Binding Cords are made from Super Linen of great strength, very hard twisted and twice doubled. They are attached to strong RUSTLESS Springs under tension, and the method adopted ensures PERMANENT RESILIENCE of the Cords. Any slack that may develop is immediately compensated for and the Cords will always remain taut and strong. It is impossible to overstretch the springs, as a safety check device is fitted to each.

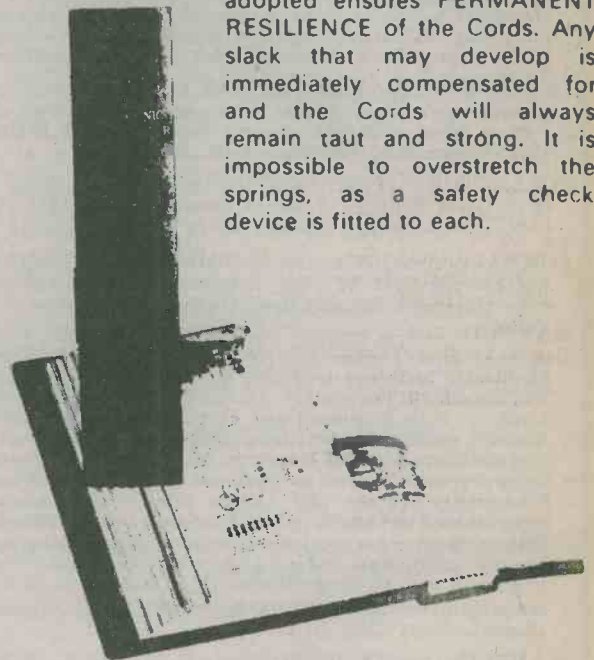

PRICE **£1.95** P.&P. 45p  
including V.A.T.

Available only from:—

**Data Publications Ltd.**  
57 Maida Vale London W9 1SN



## SMALL ADVERTISEMENTS

(Continued from page 445)

**CATHODE RAY TUBES.** Surplus types, 09J, CV2750, 946A, CV1596, CV1391 £5 each. VCR138 £6 each. Large data display Brimar, V4167/LG/L4 £15. Tektronix T5021-P2 £15. CD1016 dual beam 5MHz scopes £90. APT506 power supplies 200-500V, 6.3V at 10A, excellent condition £30. Solartron CD711S scope, requires e.h.t. xFr w/manual £20. 12AP7A Radar tube £10. Transformers 2 x 6.3V at 20A £8 each. Airmec crystal osc.213 £5. Loads of other surplus equipment! Box No. G387.

**FOR SALE:** Wide angle 9.5mm cine equipment: camera, projector, screen, etc. Also several other 9.5mm cine cameras. S.A.E. for details. Box No. G388.

**FOR SALE:** 50 2W zeners £1.00. Switch cleaner £1.00. 1N4007 diodes 7p. Reed relay inserts 25p. Miniature relays 25p. L.E.D.'s 10p. Fuseholders 10p. Electronic shooting game £5.00. Electronic blackjack game £6.00. Radio control car £7.50. Voice controlled ladybird toy £15.00. J. Fulton, Derrynaseer, Dromore, Co. Tyrone, N. Ireland.

**FOR SALE:** Sinclair MK14 mini-microprocessor with power supply. £45.00 o.n.o. Box G389.

**WANTED:** FAX equipment, manuals, service sheets, etc. G2UK, 21 Romany Road, Oulton Broad, Lowestoft, Suffolk. NR32 3PJ.

**BOOKS TO CLEAR.** "Solid State Design for the Radio Amateur", ARRL, £3.50. "The Radio Amateur's Handbook" by Frederick Collins, £3.00. "Computers for the Amateur Constructor" by R. H. Warring, 50p. "Amateur Radio Antennas" by Harry Hooton, £1.00. "Ham Antenna Construction Projects" by J. A. Stanley, 75p. "Ham RTTY" by W2NSD, 50p. "The New RTTY Handbook" by Byron Kretzman, £1.00. "RTTY from A to Z" by Durward J. Tucker, £1.00. "All about Cubical Quad Antennas" by W6SAI, £1.00. "Guide to Astronomy" by James Muirden, 40p. "Astronomy" by David Evans, £1.25. "Atomic Radiation & Life", Pelican Books, 40p. Box No. G390.

**WANTED:** Service manual, circuit of Hallicrafters SX28 receiver. Buy, borrow or copy. All expenses refunded. Maddocks, 70 Kings Road, Southsea, Hants. Telephone: Portsmouth 29129.

### PERSONAL

**JANE SCOTT FOR GENUINE FRIENDS.** Introductions to opposite sex with sincerity and thoughtfulness. Details free. Stamp to: Jane Scott, 3/Con North St. Quadrant, Brighton, Sussex, BN1 3GJ.

**IF YOU HAVE ENJOYED A HOLIDAY** on the Norfolk Broads, why not help to preserve these beautiful waterways. Join the Broads Society and play your part in determining Broadlands future. Further details from: — The Hon. Membership Secretary, The Broads Society, "Icknield," Hilly Plantation, Thorpe St. Andrew, Norwich, NR8 85S.

**BROADLANDS RESIDENTIAL CLUB** for elderly people. Are you recently retired and looking for a home? We have a delightful top floor room overlooking Oulton Broad, facing south. Write to: The Warden, Broadlands Residential Club, Borrow Road, Oulton Broad, Lowestoft, Suffolk.

**SPONSORS** required for exciting scientific project Norwich Astronomical Society are building a 30" telescope to be housed in a 20" dome of novel design. All labour being given by volunteers. Already supported by Industry and Commerce in Norfolk. Recreational. Educational. You can be involved. Write to: NAS Secretary, 195 White Woman Lane, Old Catton, Norwich, Norfolk.

# PLAIN-BACKED SELF-BINDERS

## for your other magazines

(Maximum Format 11¼" x 8¼")

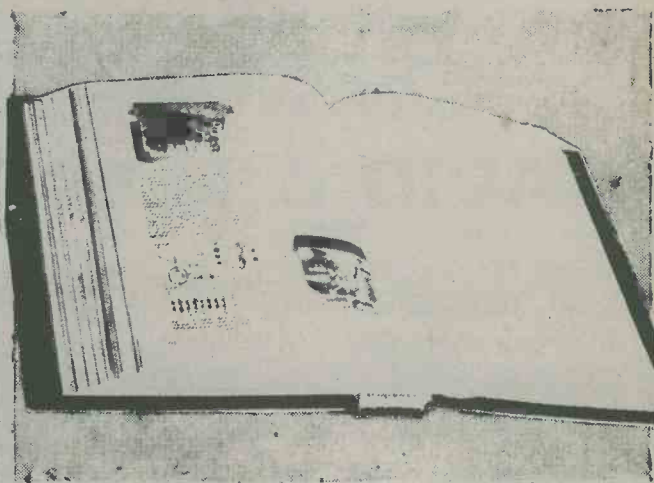

The "CORDEX" Patent Self-Binding Case will keep your copies in mint condition. Issues can be inserted or removed with the greatest of ease. Specially constructed Binding cords are made from Super Linen of great strength, very hard twisted and twice doubled. They are attached to strong RUSTLESS Springs under tension, and the method adopted ensures PERMANENT RESILIENCE of the Cords. Any slack that may develop is immediately compensated for, and the Cords will always remain taut and strong. It is impossible to overstretch the springs, as a safety check device is fitted to each.

**COLOURS: MAROON OR GREEN**

(If choice not stated, colour available will be sent)

**PRICE £1.95** p. & p. 45p  
including V.A.T.

Available only from:—

**Data Publications Ltd.**  
57 Maida Vale London W9 1SN

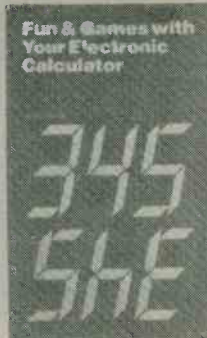
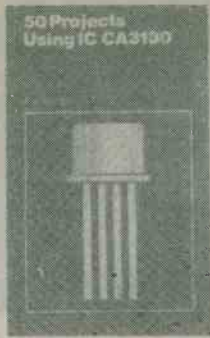

# DIRECT READER SERVICE

## RADIO & ELECTRONICS BOOKS

17. Solid State Power Supply Handbook	85p	35. Fun and Games with your Electronic Calculator	75p
18. 50 Projects Using IC CA3130	£1.25	36. 50 (FET) Field Effect Transistor Projects	£1.25
19. 50 CMOS IC Projects	£1.25	37. 50 Simple L.E.D. Circuits	75p
20. A Practical Introduction to Digital IC's	95p	38. How to Make Walkie-Talkies	£1.25
22. Beginners Guide to Building Electronic Projects	£1.25	39. IC 555 Projects	£1.75
23. Essential Theory for the Electronics Hobbyist	£1.25	40. Projects in Opto-Electronics	£1.25
25. 79 Electronic Novelty Circuits	£1.00	41. Radio Circuits Using IC's	£1.35
26. 52 Projects Using IC741	95p	42. Mobile Discotheque Handbook	£1.35
27. How to Build Your Own Electronic and Quartz Controlled Watches & Clocks	85p	43. Electronic Projects for Beginners	£1.35
28. Two Transistor Electronic Projects	85p	44. Popular Electronic Projects	£1.45
29. How to Build Your Own Metal and Treasure Locators	£1.00	45. IC LM3900 Projects	£1.35
30. Electronic Calculator Users Handbook	95p	46. Electronic Music and Creative Tape Recording	£1.25
31. Practical Repair and Renovation of Colour TVs (Reprinting)	£1.25	47. Practical Electronic Calculations and Formulae	£2.25
32. Handbook of IC Audio Preamplifier and Power Amplifier Construction	£1.25	48. Radio Stations Guide	£1.45
33. 50 Circuits Using Germanium, Silicon and Zener Diodes	75p	49. Electronic Security Devices	£1.45
34. 50 Projects Using Relays, SCR's and TRIACS	£1.25	50. How to Build Your Own Solid State Oscilloscope	£1.50
		51. 50 Circuits Using 7400 Series IC's	£1.45
		52. Second Book of CMOS IC Projects	£1.50
		53. Practical Construction of Pre-Amps, Tone Controls, Fitters & Attenuators	£1.45
		54. Beginners Guide to Digital Techniques	95p

**POSTAGE: 20p PER BOOK. IF MORE THAN 3 BOOKS ORDERED: 10p PER BOOK**

To: Data Publications Ltd., 57 Maida Vale, London W9 1SN

Please send me within 21 days .....copy/copies  
 Book Nos:.....

I enclose Postal Order/Cheque for £.....

Name .....  
 Address .....

(Block Letters Please)

(We regret this offer is only available to readers in the U.K.)